

CEILING MOUNTING LEDLUX-SPOT2



Thanks to the special design of all LED lenses we can cover all kind of applications such as corridors (escape route) and open areas (escape route lighting)

Vďaka špeciálnym LED šošovkám dokážeme pokryť všetky typy aplikácií ako sú chodby / koridory (escape route) a otvorené priestory (anti-panic)



Light source	LED 5000K
Installed load	5.5W/5.7VA (maintained M) 1.9W/4.0VA (non-maintained NM) 3.5W/4.6VA (CBS)
Housing colour	RAL9003 White RAL9006 Grey
Application	Anti-panic lighting
Max room illumination	up to 126m² > 0.5lx

Light source	LED 5000K
Installed load	5.5W/5.7VA (maintained M) 1.9W/4.0VA (non-maintained NM) 3.5W/4.6VA (CBS)
Housing colour	RAL9003 White RAL9006 Grey
Application	Escape route lighting
Max luminaire spacing	up to 23,5m > 1lx

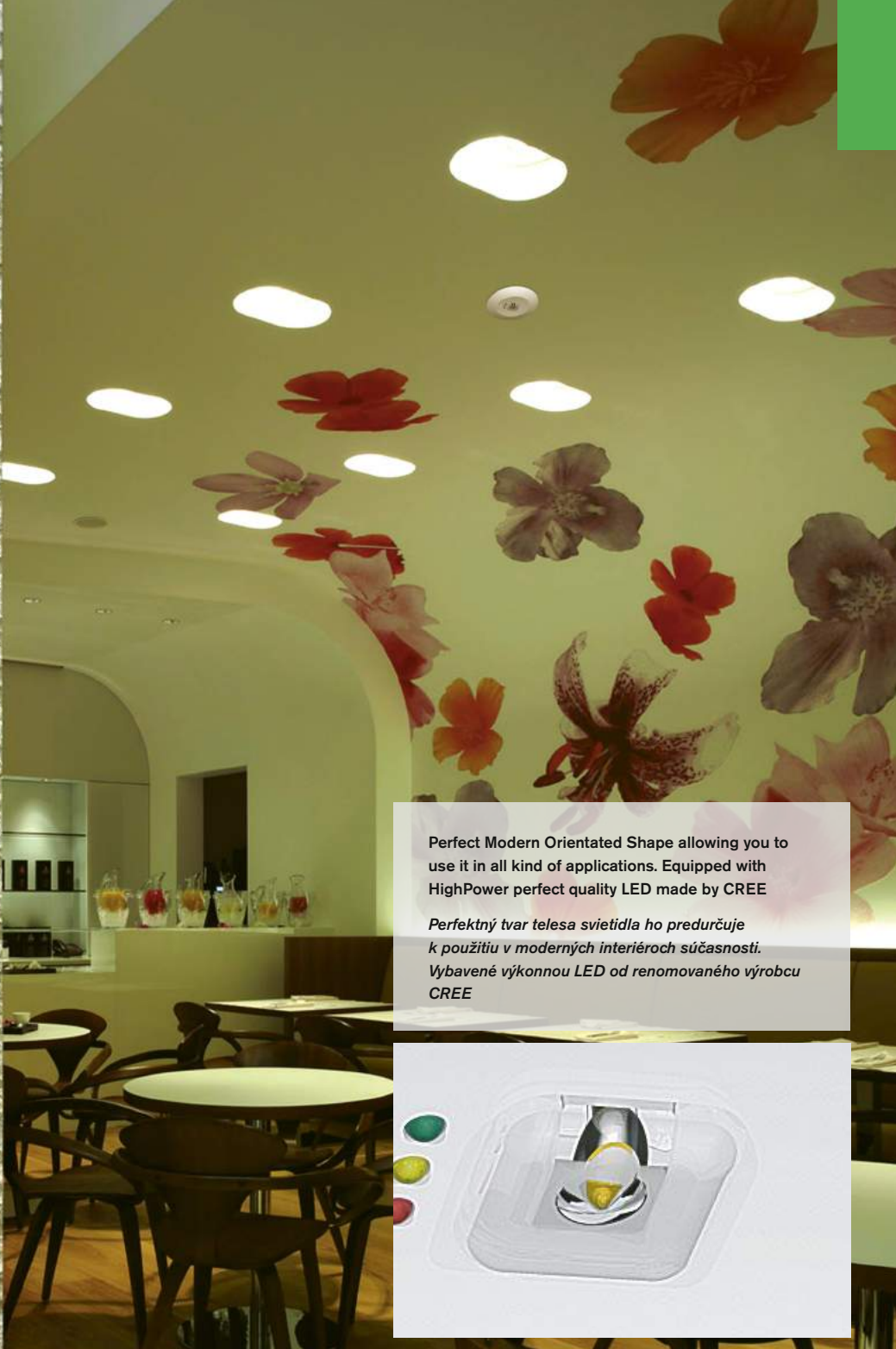

Perfect Modern Orientated Shape allowing you to use it in all kind of applications. Equipped with HighPower perfect quality LED made by CREE

Perfektný tvar telesa svietidla ho predurčuje k použitiu v moderných interiéroch súčasnosti. Vybavené výkonnou LED od renomovaného výrobcu CREE



AUTOTEST/CENTRALTEST
(only all MULTILED-SPOT-AT/ATXL/ATRF versions):
Monitor status by 3x LEDs and TEST button

AUTOTEST/CENTRALTEST
(len pre všetky MULTILED-SPOT-AT/ATXL/ATRF):
3x LED pre signalizáciu stavu svietidla a TEST tlačítko

"ONE HAND" tool free installation friendly springs allowing easy and fast recessed installation of the luminaire

Špeciálne tvarované úchytné pružiny dovoľujúce pohodlnú montáž svietidla do stropu jednou rukou bez nutnosti použitia dodatočných nástrojov

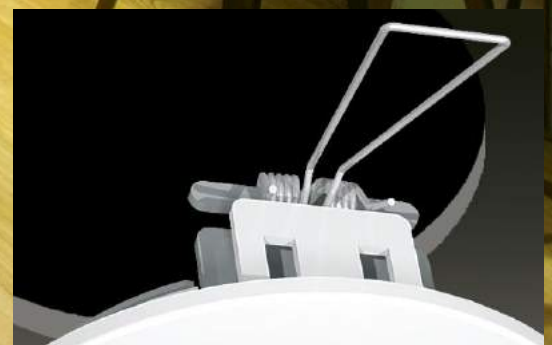

ASSORTMENT LEDLUX-SPOT2

LOW CEILING Applications <4m

LEDLUX-SPOT2 type serie is equipped with the combination of HighPower LED and sophisticated optics. Thanks to the both maximum efficiency and optimal light distribution result in the need for a low number of luminaires for emergency lighting in conformity with relevant standards. It is completely independent of general lighting. Thanks to LEDLUX-SPOT2 design the installation and maintenance is quick and simple. The luminaire proves its application flexibility with its range of installation options.

Moderný a nenápadný design vychádzajúci z kvalitných materiálov predurčuje svietidlo LEDLUX-SPOT2 pre núdzové osvetlenie v súlade s relevantnými normami plne nezávislým na hlavnom osvetlení. Svietidlá sú vybavené vyváženou kombináciou HighPower LED a špeciálnej optiky, čo zaručuje maximálnu účinnosť a optimálnu distribúciu svetla. Vďaka tomu je potrebný malý počet núdzových svietidiel pre vašu aplikáciu. LEDLUX-SPOT2 dokazuje svoju aplikáciu flexibilitu vďaka širokej typovej rade s rôznymi inštaláčnymi možnosťami.

Light source	LED 5000K
Installed load	5.5W/5.7VA (maintained M) 1.9W/4.0VA (non-maintained NM) 3.5W/4.6VA (CBS)
Housing colour	RAL9003 White RAL9006 Grey
Application	Escape route lighting Anti-panic lighting

NÍZKY STROP Aplikácia <4m



C.LEDLUX-SPOT-V-A
MULTILED-SPOT-V-A
(Page No.140)



C.LEDLUX-SPOT-P-A / MULTILED-SPOT-P-A
(Page No.146)



C.LEDLUX-SPOT-V-B
MULTILED-SPOT-V-B
(Page No.144)



C.LEDLUX-SPOT-P-B / MULTILED-SPOT-P-B
(Page No.150)

HIGH CEILING Applications >4m

HIGH CEILING application LEDLUX-SPOT2 HCA/HCB type series is equipped with the combination of all 2xHigh-Power LEDs, sophisticated optics and powerful battery. Thanks to all the high light output, maximum efficiency and optimal light distribution result in the need for a low number of luminaires for high ceiling application emergency lighting in conformity with relevant standards. It is completely independent of general lighting. Thanks to LEDLUX-SPOT2 HCA/HCB design the installation and maintenance is quick and simple.

Typová rada LEDLUX-SPOT2 HCA/HCB je určená pre núdzové osvetlenie priestorov s vysokou výškou stropu. Moderný a nenápadný design vychádzajúci z kvalitných materiálov predurčuje svietidlo LEDLUX-SPOT2 pre núdzové osvetlenie v súlade s relevantnými normami plne nezávislým na hlavnom osvetlení. Svietidlá sú vybavené vyváženou kombináciou 2xHighPower LED, špeciálnej optiky a výkonnej batérie, čo zaručuje vysoký svetelný tok, maximálnu účinnosť a optimálnu distribúciu svetla. Vďaka tomu je potrebný malý počet núdzových svietidiel pre vašu aplikáciu. Inštalácia a údržba svietidiel je rýchla a jednoduchá.

Light source	LED 5000K 410lm
Housing colour	RAL9003 White RAL9006 Grey
Application	High Ceiling Escape route lighting High Ceiling Anti-panic lighting



C.LEDLUX-SPOT-P-HCA / MULTILED-SPOT-P-HCA
(Page No.154)



C.LEDLUX-SPOT-P-HCB / MULTILED-SPOT-P-HCB
(Page No.158)

NÍZKY STROP Aplikácia <4m

LOW CEILING Applications <4m

LEDLUX-SPOT2-A-V / LEDLUX-SPOT2-A-P

escape routes lighting

LED emergency luminaire for escape route lighting in accordance with EN1838
Maximum luminaire spacing : up to 23,5m>1lx

LED núdzové svietidlo pre osvetlenie únikovej cesty v súlade s EN1838
Maximálny rozostup svietidiel: až 23,5m>1lx

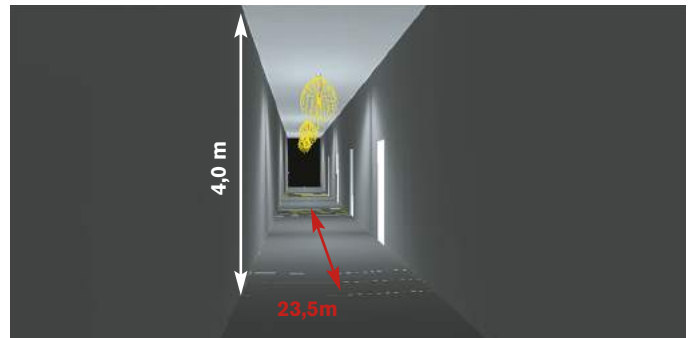
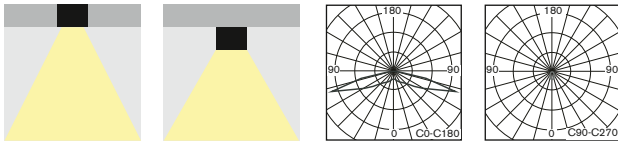

LEDLUX-SPOT2-B-V / LEDLUX-SPOT2-B-P

Anti-panic in open area applications

LED emergency luminaire for anti-panic lighting in accordance with EN1838
Maximum room illumination: up to 126m²>0,5lx

LED núdzové svietidlo pre osvetlenie otvorených priestorov v súlade s EN1838
Maximálna plocha osvetlenia v otvorenom priestore: až 126m²>0,5lx

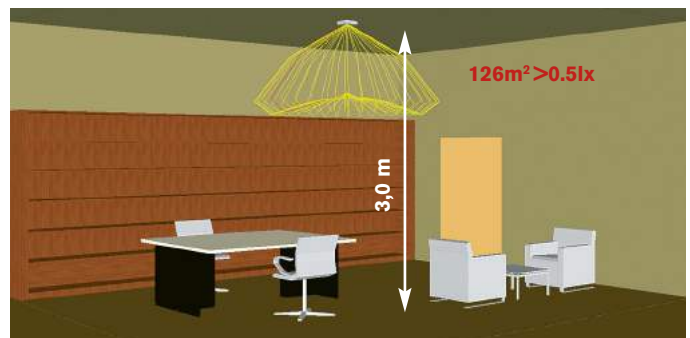
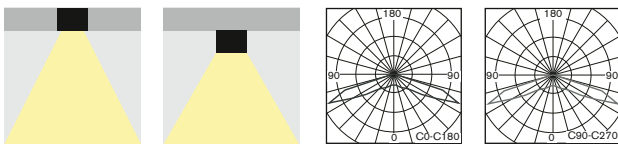

Look up pages No. 328-335 for 1lx Spacing tables
Pozri str. 328-335 pre rozmiestnenie svietidiel na dosiahnutie 1lx

VYSOKÝ STROP Aplikácia >4m

HIGH CEILING Applications >4m

LEDLUX-SPOT2-HCA-P

escape routes lighting for **HIGH CEILING** applications

LED emergency luminaire for escape route lighting in accordance with EN1838
Designed for high ceiling corridor application up to 9m mounting height
Maximum luminaire spacing : up to 28,3m>1lx

LED núdzové svietidlo pre osvetlenie únikovej cesty v súlade s EN1838
Určené pre montáž na strop až do výšky 9m
Maximálny rozostup svietidiel: až 28,3m>1lx

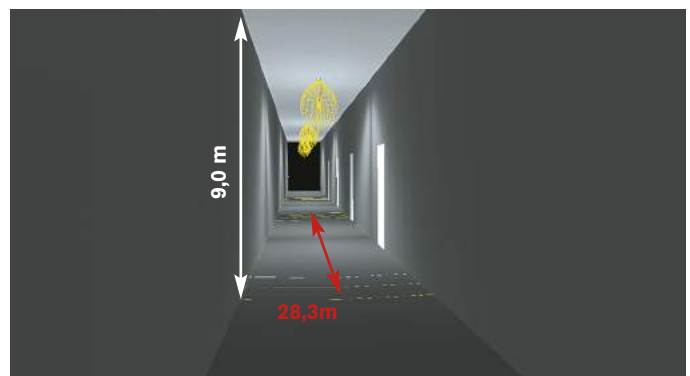
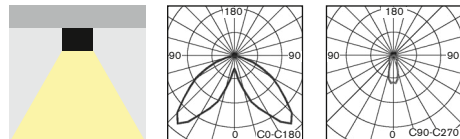

LEDLUX-SPOT2-HCB-P

Anti-panic in **HIGH CEILING** open area applications

LED emergency luminaire for anti-panic lighting in accordance with EN1838
Designed for high ceiling open area application up to 8m mounting height
Maximum room illumination: up to 277m²>0,5lx

LED núdzové svietidlo pre osvetlenie otvorených priestorov v súlade s EN1838
Určené pre montáž na strop až do výšky 8m
Maximálna plocha osvetlenia v otvorenom priestore: až 277m²>0,5lx

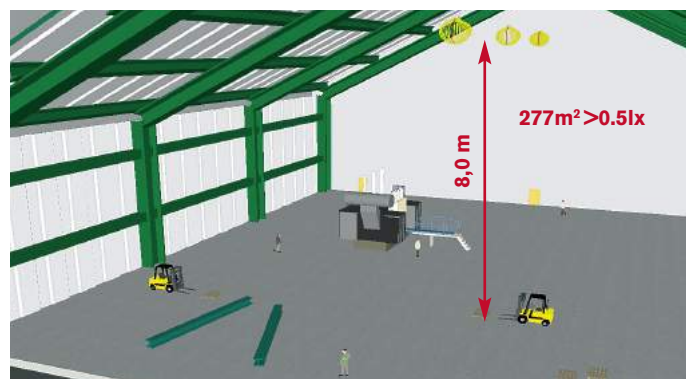
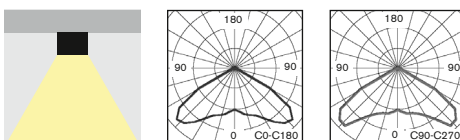

Look up pages No. 210-217 for 1lx Spacing tables
Pozri str.210-217 pre rozmiestnenie svietidiel na dosiahnutie 1lx

RECESSED ESCAPE ROUTE LIGHTING LEDLUX-SPOT2-A-V

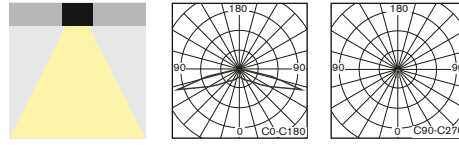

• Small and powerful **recessed LED** non-maintained (NM), maintained (M) or centralised (C) emergency lighting for perfect light distribution **especially** designed for a **corridor applications (escape route illumination to EN1838)**. It is available in all following versions:

- **AUTOTEST** (-AT)
- **DALI**
- **CENTRALTEST** (-ATXL) for **ELMAX LOOK** system (look up also page No.36)
- **CENTRALTEST** (-ATRF) for **ELMAX Wireless** system (look up page No.38)
- **CENTRAL BATTERY** (C.LEDLUX-SPOT2) for **non-addressable CBS** (look up also page No.44)
- **CENTRAL BATTERY** (-ATXP) for system **ELMAX-PATROLUX & Addressable CBS** (look up also pages No.40)
- Conforming to the requirement of EN60598-2-22, EN1838, EN62034
- Design: plastic body in RAL9006 (grey) or RAL9003 (white)
- malé, výkonné LED svietidlo pre **netrvalé (NM), trvalé (M)** alebo **centrálne (C)** núdzové osvetlenie pre zapustenú montáž zaručujúce vysokú hladinu svetelného toku špeciálne navrhnuté pre osvetlenie chodieb, aj s funkciami:
 - **AUTOTEST** (-AT)
 - **DALI**
 - **CENTRALTEST** (-ATXL) pre systém ELMAX LOOK (pozri str.36)
 - **bezdrôtový CENTRALTEST** (-ATRF) pre ELMAX-Wireless systém (str.38)
 - **CENTRAL BATTERY** (C.LEDLUX-SPOT2) pre **neadresovateľné CBS** (str.44)
 - **CENTRAL BATTERY** (-ATXP) pre systém **ELMAX-PATROLUX s adresovateľnou CBS** (pozri str. 40)
- spĺňa požiadavky európskej normy EN 60598-2-22, EN1838, EN62034
- konštrukcia: teleso z plastu vo farbe RAL9006 (šedá) alebo RAL9003 (biela)

STANDARD FEATURES

STANDARDNÁ VÝBAVA

- **High efficient HighPower (120lm/W) LONGLIFE LEDs (>100.000h)**
- **NEW Advanced Electronics**
- **LONGLIFE LiFePo4 battery**
- **Special LED lens** for perfect light distribution
- **Installation Mode** (battery protection, for more details look up page No.51+142)
- **Intelligent battery charging** (intermittent charging, look up page No.51+142)
- **DIP Switch** allowing to preset following functions:
 - **INSTALLATION MODE** activation/deactivation (look up page No.51+142)
 - **Maintained mode** activation/deactivation
- Addressable CENTRALTEST communication module (for ATXL, ATRF, ATXP only)
- LEDs indicating presence of power supply and signaling failures & TEST button
- **vysoko účinné HighPower LED (120lm/W) so životnosťou min.100000h**
- **progressívna elektronická jednotka**
- **LONGLIFE LiFePo4 batéria**
 - špeciálna LED šošovka pre perfektnú distribúciu svetla
 - **Inštalčný mód** (ochrana batérie, pozri aj str.51+142)
 - **Inteligentné nabíjanie batérie** ("intermittent" nabíjanie, pozri aj str.51+142)
 - **DIP prepínač** umožňujúci prednastavenie funkcie:
 - **Inštalčný mód** aktivácia / deaktivácia (pozri aj str.51+142)
 - trvalé núdzové osvetlenie aktivácia / deaktivácia
- adresovateľný CENTRALTEST komunikačný modul (len pre ATXL, ATRF, ATXP verzie)
- signalizácia LED a TEST tlačítko

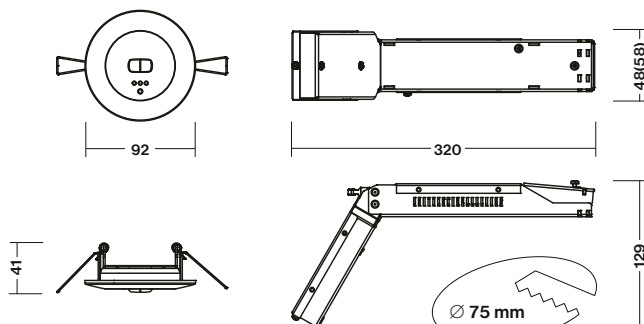
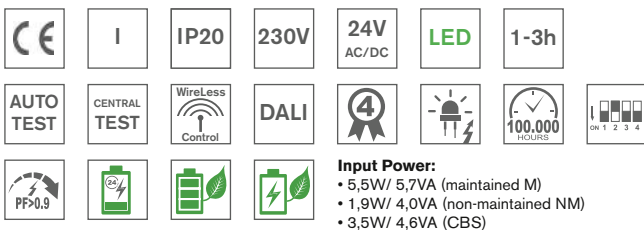

* Dimmensions in the bracket are valid for 3h versions
* rozmery v zátvorke platia pre 3h verzie

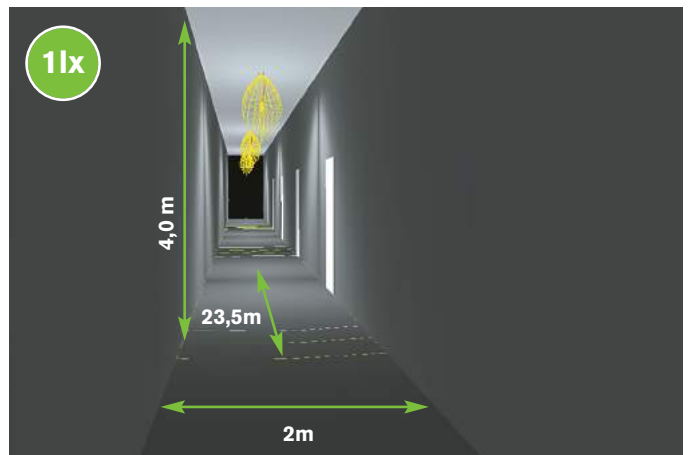



RECESSED ESCAPE ROUTE LIGHTING LEDLUX-SPOT2-A-V

1LX SPACING TABLE / ROZMIESTNENIE PRE 1LX

H (m)	Y1 (m)	Y2 (m)
2,75	8,3	20,1
3,00	8,4	20,9
3,50	7,9	22,5
4,00	7,7	23,5
4,50	7,1	23,1
5,00	6,4	21,9

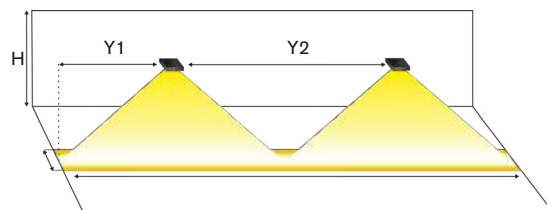

Page No.32

AUTOTEST -AT NM/M

Type	Colour	Light Source	Light Flux / Emergency mode	Battery	Order Code	Weight
MULTILED-SPOT2-A-V-AT.1h	White / biela	HighPower LED	150 lm / 150 lm	LiFePo4 6,4V/1,0Ah	182-B-301-04-00-01	0,6 kg
MULTILED-SPOT2-A-V-AT.1h	Grey / šedá	HighPower LED	150 lm / 150 lm	LiFePo4 6,4V/1,0Ah	182-B-301-04-00-02	0,6 kg
MULTILED-SPOT2-A-V-AT.3h	White / biela	HighPower LED	150 lm / 150 lm	LiFePo4 6,4V/2,0Ah	182-B-309-04-00-01	0,7 kg
MULTILED-SPOT2-A-V-AT.3h	Grey / šedá	HighPower LED	150 lm / 150 lm	LiFePo4 6,4V/2,0Ah	182-B-309-04-00-02	0,7 kg

DALI SELF-CONTAINED

Type	Colour	Light Source	Light Flux / Emergency	Battery	Order Code	Weight
MULTILED-SPOT2-A-V-DALI.1h	White / biela	HighPower LED	150 lm / 150 lm	LiFePo4 6,4V/1,0Ah	182-B-307-04-00-01	0,6 kg
MULTILED-SPOT2-A-V-DALI.1h	Grey / šedá	HighPower LED	150 lm / 150 lm	LiFePo4 6,4V/1,0Ah	182-B-307-04-00-02	0,6 kg
MULTILED-SPOT2-A-V-DALI.3h	White / biela	HighPower LED	150 lm / 150 lm	LiFePo4 6,4V/2,0Ah	182-B-305-04-00-01	0,7 kg
MULTILED-SPOT2-A-V-DALI.3h	Grey / šedá	HighPower LED	150 lm / 150 lm	LiFePo4 6,4V/2,0Ah	182-B-305-04-00-02	0,7 kg

Page No.36

CENTRALTEST -ATXL ELMAX-LOOK

Type	Colour	Light Source	Light Flux / Emergency mode	Battery	Order Code	Weight
MULTILED-SPOT2-A-V-ATXL.1h	White / biela	HighPower LED	150 lm / 150 lm	LiFePo4 6,4V/1,0Ah	182-B-310-04-00-01	0,6 kg
MULTILED-SPOT2-A-V-ATXL.1h	Grey / šedá	HighPower LED	150 lm / 150 lm	LiFePo4 6,4V/1,0Ah	182-B-310-04-00-02	0,6 kg
MULTILED-SPOT2-A-V-ATXL.3h	White / biela	HighPower LED	150 lm / 150 lm	LiFePo4 6,4V/2,0Ah	182-B-311-04-00-01	0,7 kg
MULTILED-SPOT2-A-V-ATXL.3h	Grey / šedá	HighPower LED	150 lm / 150 lm	LiFePo4 6,4V/2,0Ah	182-B-311-04-00-02	0,7 kg

Page No.38

Wireless CENTRALTEST ELMAX-ATRF

Type	Colour	Light Source	Light Flux / Emergency	Battery	Order Code	Weight
MULTILED-SPOT2-A-V-ATRF.1h	White / biela	HighPower LED	150 lm / 150 lm	LiFePo4 6,4V/1,0Ah	182-B-312-04-00-01	0,7 kg
MULTILED-SPOT2-A-V-ATRF.1h	Grey / šedá	HighPower LED	150 lm / 150 lm	LiFePo4 6,4V/1,0Ah	182-B-312-04-00-02	0,7 kg

Page No.44

CENTRAL BATTERY (CBS)

Type	Colour	Version	Light Source	Light Flux	Order Code	Weight
C.LEDLUX-SPOT2-A-V/230V AC/DC	White / biela	CBS NON-ADDRESSABLE	HighPower LED	150 lm	182-B-303-00-00-01	0,5 kg
C.LEDLUX-SPOT2-A-V/230V AC/DC	Grey / šedá	CBS NON-ADDRESSABLE	HighPower LED	150 lm	182-B-303-00-00-02	0,5 kg
C.LEDLUX-SPOT2-A-V/24V AC/DC	White / biela	CBS NON-ADDRESSABLE	HighPower LED	150 lm	182-B-313-00-00-01	0,5 kg
C.LEDLUX-SPOT2-A-V/24V AC/DC	Grey / šedá	CBS NON-ADDRESSABLE	HighPower LED	150 lm	182-B-313-00-00-02	0,5 kg

DALI CENTRAL BATTERY (CBS)

Type	Colour	Version	Light Source	Light Flux	Order Code	Weight
C.LEDLUX-SPOT2-A-V-DALI 230V AC	White / biela	DALI CBS	HighPower LED	150 lm	182-B-333-00-00-01	0,5 kg
C.LEDLUX-SPOT2-A-V-DALI 230V AC	Grey / šedá	DALI CBS	HighPower LED	150 lm	182-B-333-00-00-02	0,5 kg

Page No.40

Addressable CENTRAL BATTERY (CBS) -ATXP ELMAX-PATROLUX

Type	Colour	Version	Light Source	Light Flux	Order Code	Weight
C.LEDLUX-SPOT2-A-V-ATXPR/230V AC/DC	White / biela	ATXP CBS ADDRESSABLE	HighPower LED	150 lm	182-B-314-00-00-01	0,6 kg
C.LEDLUX-SPOT2-A-V-ATXPR/230V AC/DC	Grey / šedá	ATXP CBS ADDRESSABLE	HighPower LED	150 lm	182-B-314-00-00-02	0,6 kg

Look up pages No. 210-217 for 1lx Spacing tables
Pozri str.210-217 pre rozmiestnenie svetidiel na dosiahnutie 1lx

ANTIPANIC LIGHTING
LEDLUX-SPOT2-V



Light source	LED 5000K
Installed load	5.5W/5.7VA (maintained M) 1.9W/4.0VA (non-maintained NM) 3.5W/4.6VA (CBS)
Housing colour	RAL9003 White RAL9006 Grey
Application	Escape route lighting
Max luminaire spacing up to	23,5m > 1lx



DIP SWITCH FEATURES No. 2-4

DIP PREPÍNAČ č. 2-4 - FUNKCIE

SELF-CONTAINED BATTERY VERSIONS

	INSTALLATION MODE SET UP	ON OFF <input type="checkbox"/> <input type="checkbox"/> <input type="checkbox"/> <input type="checkbox"/> 1 2 3 4	DEFFAULT SETTING OFF - ACTIVATED ON - DEACTIVATED
M / NM	NON-MAINTAINED/ MAINTAINED MODE (NM/ M) SET UP	ON OFF <input type="checkbox"/> <input type="checkbox"/> <input type="checkbox"/> <input type="checkbox"/> 1 2 3 4	DEFFAULT SETTING ON - MAINTAINED OFF - NON-MAINTAINED
AT / ATXL	AUTOTEST AT / CENTRALTEST ATXL MODE SET UP	ON OFF <input type="checkbox"/> <input type="checkbox"/> <input type="checkbox"/> <input type="checkbox"/> 1 2 3 4	DEFFAULT SETTING OFF - AUTOTEST ON - CENRALTEST
NO AT	NO-AUTOTEST MODE SET UP	ON OFF <input type="checkbox"/> <input type="checkbox"/> <input type="checkbox"/> <input type="checkbox"/> 1 2 3 4	DEFFAULT SETTING OFF - AUTOTEST ACTIVE ON - NO-AUTOTEST

TO SEE THE CHANGE PUSH EITHER TEST BUTTON OR DISCONNECT THE FIXTURE FROM BOTH THE MAINS 230V AND BATTERY

PO PRESTAVENÍ STLAČTE TEST ALEBO ODPOJTE BATÉRIU A 230V NAPAĀANIE NA AKTIVÁCIU ZMENY

ANTIPANIC LIGHTING LEDLUX-SPOT2-V

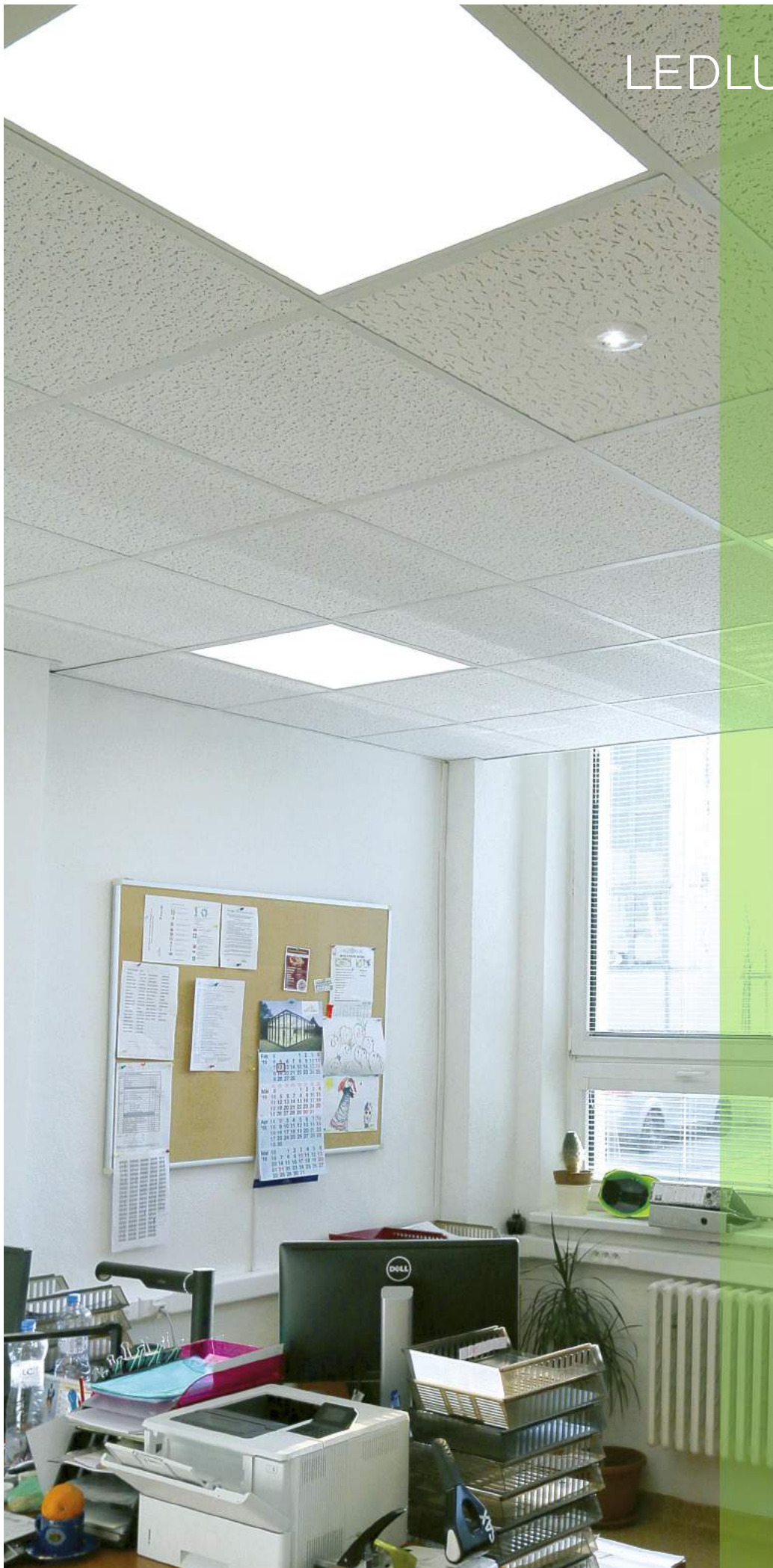

Light source	LED 5000K
Installed load	5.5W/5.7VA (maintained M) 1.9W/4.0VA (non-maintained NM)
Housing colour	RAL9003 White RAL9006 Grey
Application	Anti-panic lighting
Max room illumination	up to 126m ² > 0.5lx

RECESSED ANTIPANIC LIGHTING LEDLUX-SPOT2-B-V

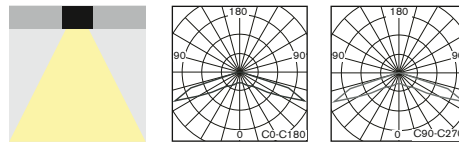
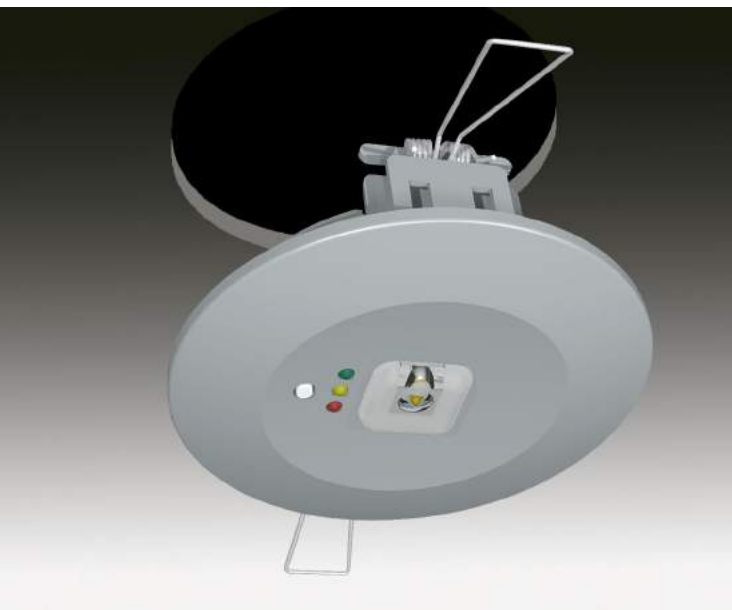

- Small and powerful **recessed LED** non-maintained (NM), maintained (M) or centralised (C) emergency lighting for perfect **wide beam** light distribution **especially designed for a large OPEN AREAS** such as offices, shops, reception desks, lift areas, entrance halls, classrooms, etc.

It is available in all following versions:

- **AUTOTEST (-AT) or DALI**
- **CENTRALTEST (-ATXL)** for **ELMAX LOOK** system (look up also page No.36)
- **CENTRALTEST (-ATRF)** for **ELMAX Wireless** system (page No.38)
- **CENTRAL BATTERY (C.LEDLUX-SPOT2)** for **non-addressable CBS** (look up also page No.44)
- **CENTRAL BATTERY (-ATXP)** for system **ELMAX-PATROLUX & Addressable CBS** (look up also page No.40)
- Conforming to the requirement of EN60598-2-22, EN1838, EN62034
- Design: plastic body in RAL9006 (grey) or RAL9003 (white)
- malé, výkonné LED svietidlo pre **netrválé (NM), trvalé (M)** alebo **centrálné (C)** núdzové osvetlenie pre zapustenú montáž zaručujúce vysokú hladinu svetelného toku špeciálne navrhnuté pre osvetlenie otvorených priestorov (vestibul, kancelária, reštaurácia, školské priestory,...) aj s funkciami:
 - **AUTOTEST (-AT)** alebo **DALI**
 - **CENTRALTEST (-ATXL)** pre systém **ELMAX LOOK** (pozri str.36)
 - **bezdrôtový CENTRALTEST (-ATRF)** pre **ELMAX Wireless** systém (str.38)
 - **CENTRAL BATTERY (C.LEDLUX-SPOT2)** pre **neadresovateľné CBS** (pozri aj str.44)
 - **CENTRAL BATTERY (-ATXP)** pre systém **ELMAX-PATROLUX s adresovateľnou CBS** (pozri str. 40)
- spĺňa požiadavky európskej normy EN 60598-2-22, EN1838, EN62034
- konštrukcia: teleso z plastu vo farbe RAL9006 alebo RAL9003 (biela)

STANDARD FEATURES

ŠTANDARDNÁ VÝBAVA

- **High efficient HighPower (120lm/W) LONGLIFE LEDs (>100.000h)**
- **NEW Advanced Electronics**
- **LONGLIFE LiFePo4 battery**
- **Special LED lens** for perfect light distribution
- **Installation Mode** (battery protection, for more details look up page No.51+142)
- **Intelligent battery charging** (intermittent charging, look up page No.51+142)
- **DIP Switch** allowing to preset following functions:
 - **INSTALLATION MODE** activation/deactivation (look up page No.51+142)
 - **Maintained mode** activation /deactivation
- Addressable CENTRALTEST communication module (for ATXL, ATRF, ATXP only)
- LEDs indicating presence of power supply and signaling failures & TEST button
- **vysoko účinné HighPower LED (120lm/W) so životnosťou min.100000h**
- **progresívna elektronická jednotka**
- **LONGLIFE LiFePo4 batéria**
- špeciálna LED šošovka pre perfektnú distribúciu svetla
- **Inštaláčny mód** (ochrana batérie, pozri aj str.51+142)
- **Inteligentné nabíjanie batérie** ("intermittent" nabíjanie, pozri aj str.51+142)
- **DIP prepínač** umožňujúci prednastavenie funkcií:
 - **Inštaláčny mód** aktivácia / deaktivácia (pozri aj str.51+142)
 - trvalé núdzové osvetlenie aktivácia / deaktivácia
- adresovateľný CENTRALTEST komunikačný modul (len pre ATXL, ATRF, ATXP verzie)
- signalizácia LED a TEST tlačítko

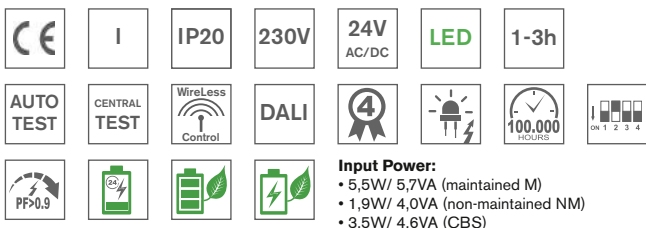

Input Power:
 • 5,5W/ 5,7VA (maintained M)
 • 1,9W/ 4,0VA (non-maintained NM)
 • 3,5W/ 4,6VA (CBS)

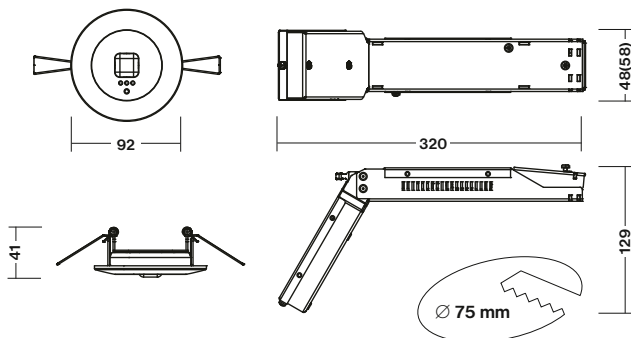

* Dimmensions in the bracket are valid for 3h versions
 * rozmery v zátvorke platia pre 3h verzie

RECESSED ANTIPANIC LIGHTING LEDLUX-SPOT2-B-V



1LX SPACING TABLE / ROZMIESTNENIE PRE 1LX				
H (m)	X1 (m)	X2 (m)	Y1 (m)	Y2 (m)
2,75	3,8	12,6	3,8	12,6
3,00	3,3	12,7	3,3	12,7
3,50	2,5	11,8	2,5	11,8
4,00	1,8	10,1	1,8	10,1

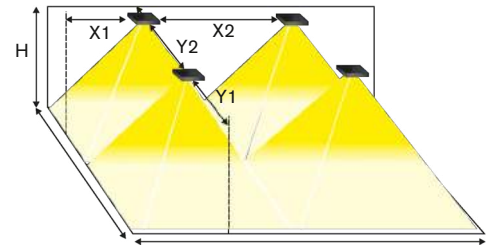

Page No.32

AUTOTEST -AT NM/M

Type	Colour	Light Source	Light Flux / Emergency mode	Battery	Order Code	Weight
MULTILED-SPOT2-B-V-AT.1h	White / biela	HighPower LED	150 lm / 150 lm	LiFePo4 6,4V/1,0Ah	182-B-302-04-00-01	0,6 kg
MULTILED-SPOT2-B-V-AT.1h	Grey / šedá	HighPower LED	150 lm / 150 lm	LiFePo4 6,4V/1,0Ah	182-B-302-04-00-02	0,6 kg
MULTILED-SPOT2-B-V-AT.3h	White / biela	HighPower LED	150 lm / 150 lm	LiFePo4 6,4V/2,0Ah	182-B-315-04-00-01	0,7 kg
MULTILED-SPOT2-B-V-AT.3h	Grey / šedá	HighPower LED	150 lm / 150 lm	LiFePo4 6,4V/2,0Ah	182-B-315-04-00-02	0,7 kg

DALI

Type	Colour	Light Source	Light Flux / Emergency mode	Battery	Order Code	Weight
MULTILED-SPOT2-B-V-DALI.1h	White / biela	HighPower LED	150 lm / 150 lm	LiFePo4 6,4V/1,0Ah	182-B-308-04-00-01	0,6 kg
MULTILED-SPOT2-B-V-DALI.1h	Grey / šedá	HighPower LED	150 lm / 150 lm	LiFePo4 6,4V/1,0Ah	182-B-308-04-00-02	0,6 kg
MULTILED-SPOT2-B-V-DALI.3h	White / biela	HighPower LED	150 lm / 150 lm	LiFePo4 6,4V/2,0Ah	182-B-306-04-00-01	0,7 kg
MULTILED-SPOT2-B-V-DALI.3h	Grey / šedá	HighPower LED	150 lm / 150 lm	LiFePo4 6,4V/2,0Ah	182-B-306-04-00-02	0,7 kg

Page No.36

CENTRALTEST -ATXL ELMAX-LOOK

Type	Colour	Light Source	Light Flux / Emergency mode	Battery	Order Code	Weight
MULTILED-SPOT2-B-V-ATXL.1h	White / biela	HighPower LED	150 lm / 150 lm	LiFePo4 6,4V/1,0Ah	182-B-316-04-00-01	0,6 kg
MULTILED-SPOT2-B-V-ATXL.1h	Grey / šedá	HighPower LED	150 lm / 150 lm	LiFePo4 6,4V/1,0Ah	182-B-316-04-00-02	0,6 kg
MULTILED-SPOT2-B-V-ATXL.3h	White / biela	HighPower LED	150 lm / 150 lm	LiFePo4 6,4V/2,0Ah	182-B-317-04-00-01	0,7 kg
MULTILED-SPOT2-B-V-ATXL.3h	Grey / šedá	HighPower LED	150 lm / 150 lm	LiFePo4 6,4V/2,0Ah	182-B-317-04-00-02	0,7 kg

Page No.38

Wireless CENTRALTEST ELMAX-ATRF

Type	Colour	Light Source	Light Flux / Emergency mode	Battery	Order Code	Weight
MULTILED-SPOT2-B-V-ATRF.1h	White / biela	HighPower LED	150 lm / 150 lm	LiFePo4 6,4V/1,0Ah	182-B-318-04-00-01	0,7 kg
MULTILED-SPOT2-B-V-ATRF.1h	Grey / šedá	HighPower LED	150 lm / 150 lm	LiFePo4 6,4V/1,0Ah	182-B-318-04-00-02	0,7 kg

Page No.44

CENTRAL BATTERY (CBS)

Type	Colour	Version	Light Source	Light Flux	Order Code	Weight
C.LEDLUX-SPOT2-B-V 230V AC/DC	White / biela	CBS NON-ADDRESSABLE	HighPower LED	150 lm	182-B-304-00-00-01	0,5 kg
C.LEDLUX-SPOT2-B-V 230V AC/DC	Grey / šedá	CBS NON-ADDRESSABLE	HighPower LED	150 lm	182-B-304-00-00-02	0,5 kg
C.LEDLUX-SPOT2-B-V 24V AC/DC	White / biela	CBS NON-ADDRESSABLE	HighPower LED	150 lm	182-B-319-00-00-01	0,5 kg
C.LEDLUX-SPOT2-B-V 24V AC/DC	Grey / šedá	CBS NON-ADDRESSABLE	HighPower LED	150 lm	182-B-319-00-00-02	0,5 kg

CENTRAL BATTERY (CBS)

Type	Colour	Version	Light Source	Light Flux	Order Code	Weight
C.LEDLUX-SPOT2-B-V-DALI 230V AC	White / biela	DALI CBS	HighPower LED	150 lm	182-B-334-00-00-01	0,5 kg
C.LEDLUX-SPOT2-B-V-DALI 230V AC	Grey / šedá	DALI CBS	HighPower LED	150 lm	182-B-334-00-00-02	0,5 kg

Page No.40

Addressable CENTRAL BATTERY (CBS) -ATXP ELMAX-PATROLUX

Type	Colour	Version	Light Source	Light Flux	Order Code	Weight
C.LEDLUX-SPOT2-B-V-ATXPR 230V AC/DC	White / biela	ATXP CBS ADDRESSABLE	HighPower LED	150 lm	182-B-320-00-00-01	0,6 kg
C.LEDLUX-SPOT2-B-V-ATXPR 230V AC/DC	Grey / šedá	ATXP CBS ADDRESSABLE	HighPower LED	150 lm	182-B-320-00-00-02	0,6 kg

Look up pages No. 210-217 for 1lx Spacing tables
Pozri str.210-217 pre rozmiestnenie svetidiel na dosiahnutie 1lx

CEILING ESCAPE ROUTE LIGHTING LEDLUX-SPOT2-A-P

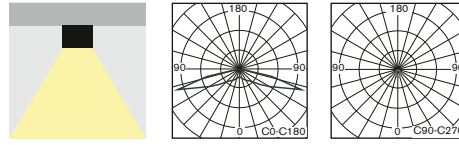

• Small and powerful **surface mounted LED** non-maintained (NM), maintained (M) or centralised (C) emergency lighting for perfect light distribution **especially** designed for a **corridor applications (escape route illumination to EN1838)**. It is available in all following versions:

- **AUTOTEST** (-AT)
- **DALI**,
- **CENTRALTEST** (-ATXL) for **ELMAX LOOK** system (look up also page No.36)
- **CENTRALTEST** (-ATRF) for **ELMAX Wireless** system (look up page No.38)
- **CENTRAL BATTERY** (C.LEDLUX-SPOT2) for **non-addressable CBS** (look up also page No.40)
- **CENTRAL BATTERY** (-ATXP) for system **ELMAX-PATROLUX & Addressable CBS** (look up also pages No.44)
- Conforming to the requirement of EN60598-2-22, EN1838, EN62034
- Design: plastic body in RAL9006 or RAL9003 (white) colour
- malé, výkonné LED svetidlo pre **netrvalé (NM), trvalé (M)** alebo **centrálne (C)** núdzové osvetlenie pre povrchovú montáž zaručujúce **vysokú hladinu svetelného toku špeciálne navrhnuté pre osvetlenie chodieb**, aj s funkciami:
 - **AUTOTEST** (-AT)
 - **DALI**
 - **CENTRALTEST** (-ATXL) pre systém ELMAX LOOK (pozri str.36)
 - **bezdrôtový CENTRALTEST** (-ATRF) pre ELMAX-Wireless systém (str.38)
 - **CENTRAL BATTERY** (C.LEDLUX-SPOT2) pre **neadresovateľné CBS** (str.44)
 - **CENTRAL BATTERY** (-ATXP) pre systém **ELMAX-PATROLUX s adresovateľnou CBS** (pozri str. 40)
- spĺňa požiadavky európskej normy EN 60598-2-22, EN1838, EN62034
- konštrukcia: teleso z plastu vo farbe RAL9006 (šedá) alebo RAL9003 (biela)

STANDARD FEATURES

STANDARDNÁ VÝBAVA

- **High efficient HighPower (120lm/W) LONGLIFE LEDs (>100.000h)**
- **NEW Advanced Electronics**
- **LONGLIFE LiFePo4 battery**
- **Special LED lens** for perfect light distribution
- **Installation Mode** (battery protection, for more details look up page No.51+142)
- **Intelligent battery charging** (intermittent charging, look up page No.51+142)
- **DIP Switch** allowing to preset following functions:
 - **INSTALLATION MODE** activation/deactivation (look up page No.51+142)
 - **Maintained mode** activation/deactivation
- Addressable CENTRALTEST communication module (for ATXL, ATRF, ATXP only)
- LEDs indicating presence of power supply and signaling failures & TEST button
- **vysoko účinné HighPower LED (120lm/W) so životnosťou min.100000h**
- **progressívna elektronická jednotka**
- **LONGLIFE LiFePo4 batéria**
- špeciálna LED šošovka pre perfektnú distribúciu svetla
- **Inštalčný mód** (ochrana batérie, pozri aj str.51+142)
- **Inteligentné nabíjanie batérie** ("intermittent" nabíjanie, pozri aj str.51+142)
- **DIP prepínač** umožňujúci prednastavenie funkcií:
 - **Inštalčný mód** aktivácia / deaktivácia (pozri aj str.51+142)
 - **trvalé núdzové osvetlenie** aktivácia / deaktivácia
- adresovateľný CENTRALTEST komunikačný modul (len pre ATXL, ATRF, ATXP verzie)
- signalizácia LED a TEST tlačítko

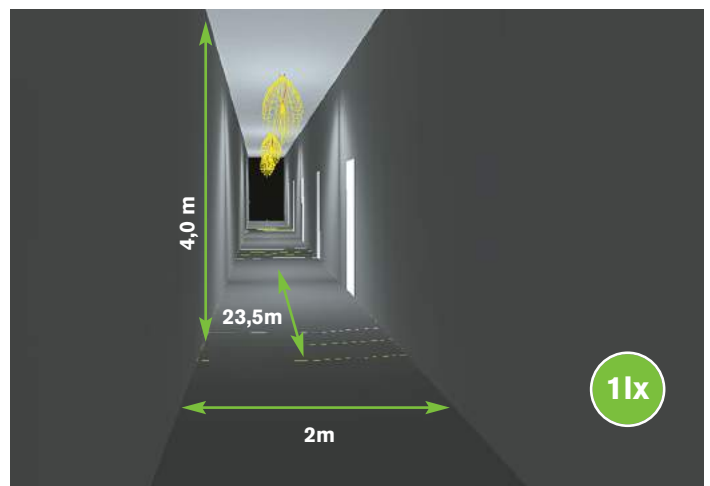
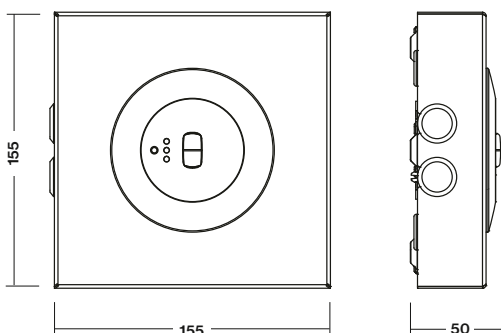
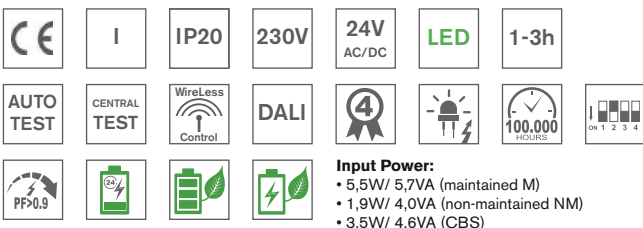

CEILING ESCAPE ROUTE LIGHTING LEDLUX-SPOT2-A-P



1LX SPACING TABLE / ROZMIESTNENIE PRE 1LX		
H (m)	Y1 (m)	Y2 (m)
2,75	8,3	20,1
3,00	8,4	20,9
3,50	7,9	22,5
4,00	7,7	23,5
4,50	7,1	23,1
5,00	6,4	21,9

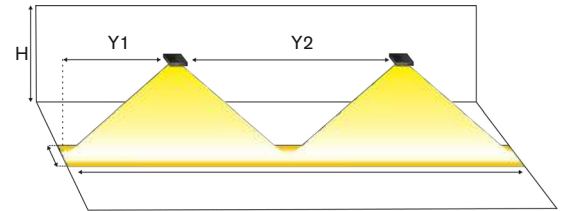

Page No.32

AUTOTEST -AT NM/M

Type	Colour	Light Source	Light Flux / Emergency mode	Battery	Order Code	Weight
MULTILED-SPOT2-A-P-AT.1h	White / biela	HighPower LED	150 lm / 150 lm	LiFePo4 6,4V/1,0Ah	182-B-202-04-00-01	0,7 kg
MULTILED-SPOT2-A-P-AT.1h	Grey / šedá	HighPower LED	150 lm / 150 lm	LiFePo4 6,4V/1,0Ah	182-B-202-04-00-02	0,7 kg
MULTILED-SPOT2-A-P-AT.3h	White / biela	HighPower LED	150 lm / 150 lm	LiFePo4 6,4V/2,0Ah	182-B-206-04-00-01	0,8 kg
MULTILED-SPOT2-A-P-AT.3h	Grey / šedá	HighPower LED	150 lm / 150 lm	LiFePo4 6,4V/2,0Ah	182-B-206-04-00-02	0,8 kg

DALI SELF-CONTAINED

Type	Colour	Light Source	Light Flux / Emergency	Battery	Order Code	Weight
MULTILED-SPOT2-A-P-DALI.1h	White / biela	HighPower LED	150 lm / 150 lm	LiFePo4 6,4V/1,0Ah	182-B-207-04-00-01	0,7 kg
MULTILED-SPOT2-A-P-DALI.1h	Grey / šedá	HighPower LED	150 lm / 150 lm	LiFePo4 6,4V/1,0Ah	182-B-207-04-00-02	0,7 kg
MULTILED-SPOT2-A-P-DALI.3h	White / biela	HighPower LED	150 lm / 150 lm	LiFePo4 6,4V/2,0Ah	182-B-208-04-00-01	0,8 kg
MULTILED-SPOT2-A-P-DALI.3h	Grey / šedá	HighPower LED	150 lm / 150 lm	LiFePo4 6,4V/2,0Ah	182-B-208-04-00-02	0,8 kg

Page No.36

CENTRALTEST -ATXL ELMAX-LOOK

Type	Colour	Light Source	Light Flux / Emergency mode	Battery	Order Code	Weight
MULTILED-SPOT2-A-P-ATXL.1h	White / biela	HighPower LED	150 lm / 150 lm	LiFePo4 6,4V/1,0Ah	182-B-209-04-00-01	0,7 kg
MULTILED-SPOT2-A-P-ATXL.1h	Grey / šedá	HighPower LED	150 lm / 150 lm	LiFePo4 6,4V/1,0Ah	182-B-209-04-00-02	0,7 kg
MULTILED-SPOT2-A-P-ATXL.3h	White / biela	HighPower LED	150 lm / 150 lm	LiFePo4 6,4V/2,0Ah	182-B-210-04-00-01	0,8 kg
MULTILED-SPOT2-A-P-ATXL.3h	Grey / šedá	HighPower LED	150 lm / 150 lm	LiFePo4 6,4V/2,0Ah	182-B-210-04-00-02	0,8 kg

Page No.38

Wireless CENTRALTEST ELMAX-ATRF

Type	Colour	Light Source	Light Flux / Emergency	Battery	Order Code	Weight
MULTILED-SPOT2-A-P-ATRF.1h	White / biela	HighPower LED	150 lm / 150 lm	LiFePo4 6,4V/1,0Ah	182-B-211-04-00-01	0,7 kg
MULTILED-SPOT2-A-P-ATRF.1h	Grey / šedá	HighPower LED	150 lm / 150 lm	LiFePo4 6,4V/1,0Ah	182-B-211-04-00-02	0,7 kg

Page No.44

CENTRAL BATTERY (CBS)

Type	Colour	Version	Light Source	Light Flux	Order Code	Weight
C.LEDLUX-SPOT2-A-P/230V AC/DC	White / biela	CBS NON-ADDRESSABLE	HighPower LED	150 lm	182-B-204-00-00-01	0,6 kg
C.LEDLUX-SPOT2-A-P/230V AC/DC	Grey / šedá	CBS NON-ADDRESSABLE	HighPower LED	150 lm	182-B-204-00-00-02	0,6 kg
C.LEDLUX-SPOT2-A-P/24V AC/DC	White / biela	CBS NON-ADDRESSABLE	HighPower LED	150 lm	182-B-212-00-00-01	0,6 kg
C.LEDLUX-SPOT2-A-P/24V AC/DC	Grey / šedá	CBS NON-ADDRESSABLE	HighPower LED	150 lm	182-B-212-00-00-02	0,6 kg

DALI CENTRAL BATTERY (CBS)

Type	Colour	Version	Light Source	Light Flux	Order Code	Weight
C.LEDLUX-SPOT2-A-P-DALI 230V AC	White / biela	DALI CBS	HighPower LED	150 lm	182-B-238-00-00-01	0,6 kg
C.LEDLUX-SPOT2-A-P-DALI 230V AC	Grey / šedá	DALI CBS	HighPower LED	150 lm	182-B-238-00-00-02	0,6 kg

Page No.40

Addressable CENTRAL BATTERY (CBS) -ATXP ELMAX-PATROLUX

Type	Colour	Version	Light Source	Light Flux	Order Code	Weight
C.LEDLUX-SPOT2-A-P-ATXPR/230V AC/DC	White / biela	ATXP CBS ADDRESSABLE	HighPower LED	150 lm	182-B-213-00-00-01	0,6 kg
C.LEDLUX-SPOT2-A-P-ATXPR/230V AC/DC	Grey / šedá	ATXP CBS ADDRESSABLE	HighPower LED	150 lm	182-B-213-00-00-02	0,6 kg

Look up pages No. 210-217 for 1lx Spacing tables
Pozri str.210-217 pre rozmiestnenie svetidiel na dosiahnutie 1lx

CEILING ESCAPE ROUTE LIGHTING LEDLUX-SPOT2-A-P

Light source	LED 5000K
Installed load	5.5W/5.7VA (maintained M)
	1.9W/4.0VA (non-maintained NM)
	3.5W/4.6VA (CBS)
Housing colour	RAL9003 White
	RAL9006 Grey
Application	Escape route lighting
Max luminaire spacing	up to 23,5m > 1lx

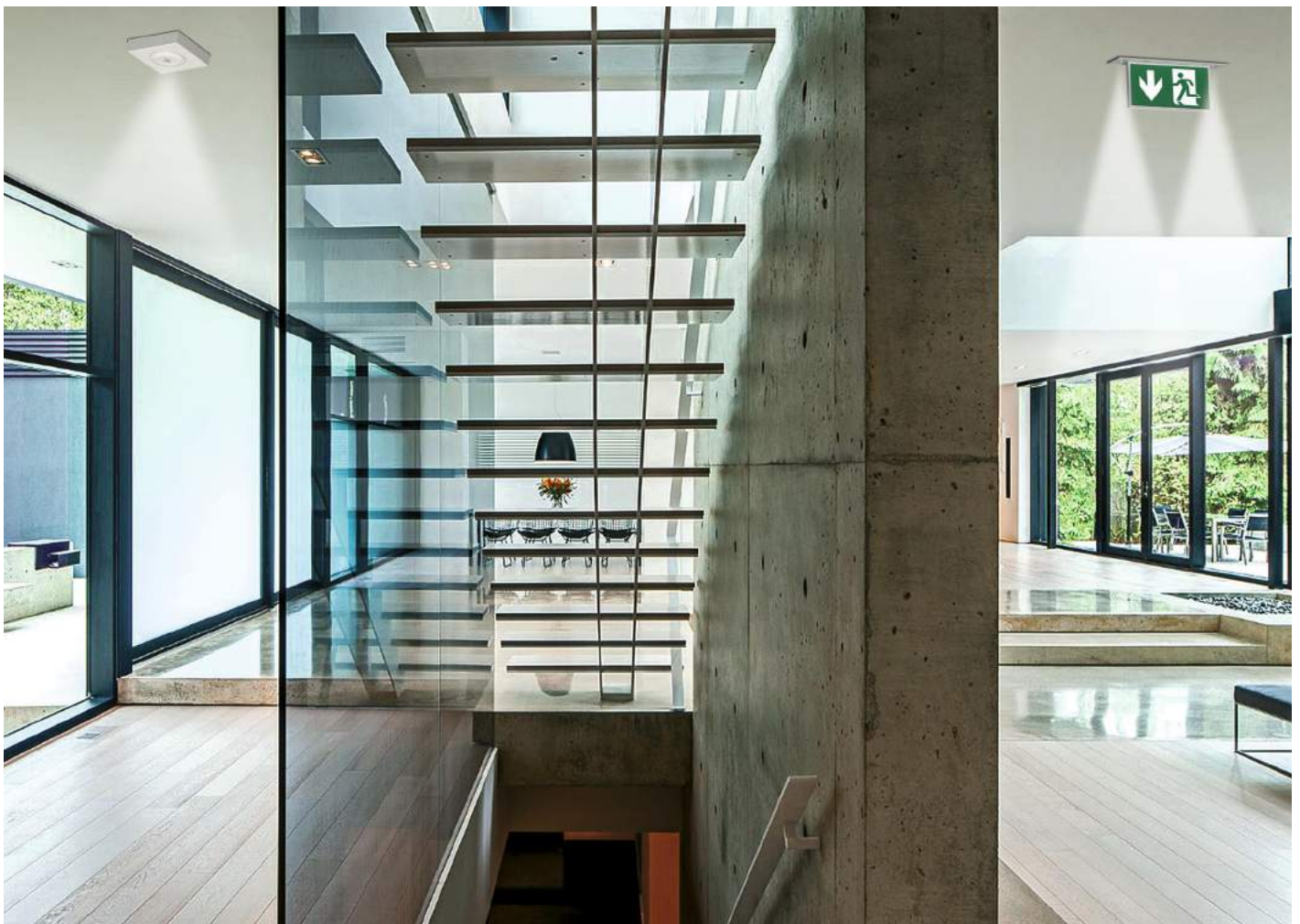

CEILING ANTIPANIC LIGHTING LEDLUX-SPOT2-B-P

Light source	LED 5000K
Installed load	5.5W/5.7VA (maintained M) 1.9W/4.0VA (non-maintained NM) 3.5W/4.6VA (CBS)
Housing colour	RAL9003 White RAL9006 Grey
Application	Anti-panic lighting
Max room illumination	up to 126m² > 0.5lx



CEILING ANTIPANIC LIGHTING LEDLUX-SPOT2-B-P

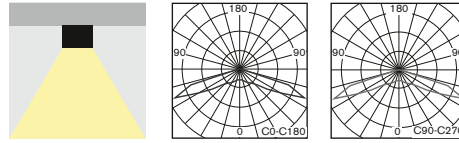

- Small and powerful **surface mounted LED** non-maintained (NM), maintained (M) or centralised (C) emergency lighting for perfect **wide beam** light distribution **especially** designed for a **large OPEN AREAS** such as **offices, shops, reception desks, lift areas, entrance halls, classrooms, etc.** It is available in all following versions:

- **AUTOTEST** (-AT)
- **DALI**
- **CENTRALTEST** (-ATXL) for **ELMAX LOOK** system (look up also page No.36)
- **CENTRALTEST** (-ATRF) for **ELMAX Wireless** system (look up page No.38)
- **CENTRAL BATTERY** (C.LEDLUX-SPOT2) for **non-addressable CBS** (page 44)
- **CENTRAL BATTERY** (-ATXP) for system **ELMAX-PATROLUX & Addressable CBS** (look up also page No.40)
- Conforming to the requirement of EN60598-2-22, EN1838, EN62034
- Design: plastic body in RAL9006 (grey) or RAL9003 (white) colour
- malé, výkonné LED svetidlo pre **netrvalé (NM), trvalé (M)** alebo **centrálne (C)** núdzové osvetlenie pre povrchovú montáž zaručujúce vysokú hladinu svetelného toku so širokou krivkou svietivosti špeciálne navrhnuté pre osvetlenie rozlohou veľkých otvorených priestorov ako napr. kancelárie, obchody, recepcie, nástupný priestor výťahov, vstupné haly školské triedy a pod., aj s funkciami:
- **AUTOTEST** (-AT)
- **DALI**
- **CENTRALTEST** (-ATXL) pre systém ELMAX LOOK (pozri str.36)
- **bezdrôtový CENTRALTEST** (-ATRF) pre ELMAX-Wireless systém (str.38)
- **CENTRAL BATTERY** (C.LEDLUX-SPOT2) pre **neadresovateľné CBS** (str.44)
- **CENTRAL BATTERY** (-ATXP) pre systém **ELMAX-PATROLUX s adresovateľnou CBS** (pozri aj str. 40)
- spĺňa požiadavky európskej normy EN 60598-2-22, EN1838, EN62034
- konštrukcia: teleso z plastu vo farbe RAL9006 (šedá) alebo RAL9003 (biela)

STANDARD FEATURES

ŠTANDARDNÁ VÝBAVA

- **High efficient HighPower (120lm/W) LONGLIFE LEDs (>100.000h)**
- **NEW Advanced Electronics**
- **LONGLIFE LiFePo4 Battery**
- **Special LED lens** for perfect light distribution
- **Installation Mode** (battery protection, for more details look up page No.51+142)
- **Intelligent battery charging** (intermittent charging, look up page No.51+142)
- **DIP Switch** allowing to preset following functions:
 - **INSTALLATION MODE** activation/deactivation (look up page No.51+142)
 - **Maintained mode** activation/deactivation
- Addressable CENTRALTEST communication module (for ATXL, ATRF, ATXP only)
- LEDs indicating presence of power supply and signaling failures & TEST button
- **vysoko účinné HighPower LED (120lm/W) so životnosťou min.100000h**
- **progresívna elektronická jednotka**
- **LONGLIFE LiFePo4 batéria**
- špeciálna LED šošovka pre perfektnú distribúciu svetla
- **Inštalčný mód** (ochrana batérie, pozri aj str.51+142)
- **Inteligentné nabíjanie batérie** ("intermittent" nabíjanie, pozri aj str.51+142)
- **DIP prepínač** umožňujúci prednastavenie funkcií:
 - **Inštalčný mód** aktivácia / deaktivácia (pozri aj str.51+142)
 - **trvalé núdzové osvetlenie** aktivácia / deaktivácia
- adresovateľný CENTRALTEST komunikačný modul (len pre ATXL, ATRF, ATXP verzie)
- signalizácia LED a TEST tlačítko



CE	I	IP20	230V	24V AC/DC	LED	1-3h
AUTO TEST	CENTRAL TEST	WireLess Control	DALI	4	100.000 HOURS	ON 1 2 3 4
PF>0.9	24V	100%	100%	Input Power: • 5,5W/ 5,7VA (maintained M) • 1,9W/ 4,0VA (non-maintained NM) • 3,5W/ 4,6VA (CBS)		

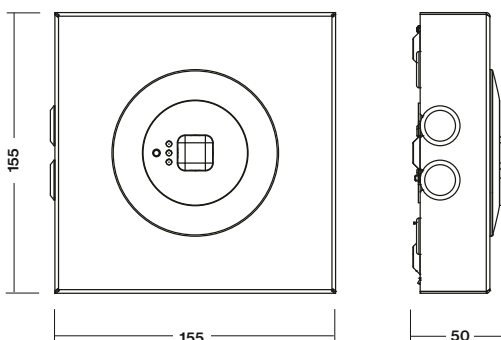

CEILING ANTIPANIC LIGHTING LEDLUX-SPOT2-B-P



1LX SPACING TABLE / ROZMIESTNENIE PRE 1LX					
H (m)	X1 (m)	X2 (m)	Y1 (m)	Y2 (m)	
2,75	3,8	12,6	3,8	12,6	
3,00	3,3	12,7	3,3	12,7	
3,50	2,5	11,8	2,5	11,8	
4,00	1,8	10,1	1,8	10,1	

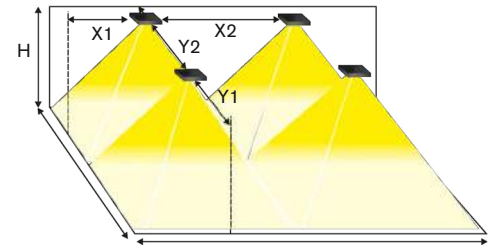

Page No.32

AUTOTEST -AT NM/M

Type	Colour	Light Source	Light Flux / Emergency mode	Battery	Order Code	Weight
MULTILED-SPOT2-B-P-AT.1h	White / biela	HighPower LED	150 lm / 150 lm	LiFePo4 6,4V/1,0Ah	182-B-203-04-00-01	0,7 kg
MULTILED-SPOT2-B-P-AT.1h	Grey / šedá	HighPower LED	150 lm / 150 lm	LiFePo4 6,4V/1,0Ah	182-B-203-04-00-02	0,7 kg
MULTILED-SPOT2-B-P-AT.3h	White / biela	HighPower LED	150 lm / 150 lm	LiFePo4 6,4V/2,0Ah	182-B-214-04-00-01	0,7 kg
MULTILED-SPOT2-B-P-AT.3h	Grey / šedá	HighPower LED	150 lm / 150 lm	LiFePo4 6,4V/2,0Ah	182-B-214-04-00-02	0,7 kg

DALI SELF-CONTAINED

Type	Colour	Light Source	Light Flux / Emergency	Battery	Order Code	Weight
MULTILED-SPOT2-B-P-DALI.1h	White / biela	HighPower LED	150 lm / 150 lm	LiFePo4 6,4V/1,0Ah	182-B-215-04-00-01	0,7 kg
MULTILED-SPOT2-B-P-DALI.1h	Grey / šedá	HighPower LED	150 lm / 150 lm	LiFePo4 6,4V/1,0Ah	182-B-215-04-00-02	0,7 kg
MULTILED-SPOT2-B-P-DALI.3h	White / biela	HighPower LED	150 lm / 150 lm	LiFePo4 6,4V/2,0Ah	182-B-216-04-00-01	0,8 kg
MULTILED-SPOT2-B-P-DALI.3h	Grey / šedá	HighPower LED	150 lm / 150 lm	LiFePo4 6,4V/2,0Ah	182-B-216-04-00-02	0,8 kg

Page No.36

CENTRALTEST -ATXL ELMAX-LOOK

Type	Colour	Light Source	Light Flux / Emergency mode	Battery	Order Code	Weight
MULTILED-SPOT2-B-P-ATXL.1h	White / biela	HighPower LED	150 lm / 150 lm	LiFePo4 6,4V/1,0Ah	182-B-217-04-00-01	0,7 kg
MULTILED-SPOT2-B-P-ATXL.1h	Grey / šedá	HighPower LED	150 lm / 150 lm	LiFePo4 6,4V/1,0Ah	182-B-217-04-00-02	0,7 kg
MULTILED-SPOT2-B-P-ATXL.3h	White / biela	HighPower LED	150 lm / 150 lm	LiFePo4 6,4V/2,0Ah	182-B-218-04-00-01	0,8 kg
MULTILED-SPOT2-B-P-ATXL.3h	Grey / šedá	HighPower LED	150 lm / 150 lm	LiFePo4 6,4V/2,0Ah	182-B-218-04-00-02	0,8 kg

Page No.38

Wireless CENTRALTEST ELMAX-ATRF

Type	Colour	Light Source	Light Flux / Emergency	Battery	Order Code	Weight
MULTILED-SPOT2-B-P-ATRF.1h	White / biela	HighPower LED	150 lm / 150 lm	LiFePo4 6,4V/1,0Ah	182-B-219-04-00-01	0,7 kg
MULTILED-SPOT2-B-P-ATRF.1h	Grey / šedá	HighPower LED	150 lm / 150 lm	LiFePo4 6,4V/1,0Ah	182-B-219-04-00-02	0,7 kg

Page No.44

CENTRAL BATTERY (CBS)

Type	Colour	Version	Light Source	Light Flux	Order Code	Weight
C.LEDLUX-SPOT2-B-P/230V AC/DC	White / biela	CBS NON-ADDRESSABLE	HighPower LED	150 lm	182-B-201-00-00-01	0,6 kg
C.LEDLUX-SPOT2-B-P/230V AC/DC	Grey / šedá	CBS NON-ADDRESSABLE	HighPower LED	150 lm	182-B-201-00-00-02	0,6 kg
C.LEDLUX-SPOT2-B-P/24V AC/DC	White / biela	CBS NON-ADDRESSABLE	HighPower LED	150 lm	182-B-220-00-00-01	0,6 kg
C.LEDLUX-SPOT2-B-P/24V AC/DC	Grey / šedá	CBS NON-ADDRESSABLE	HighPower LED	150 lm	182-B-220-00-00-02	0,6 kg

DALI CENTRAL BATTERY (CBS)

Type	Colour	Version	Light Source	Light Flux	Order Code	Weight
C.LEDLUX-SPOT2-B-P-DALI 230V AC	White / biela	DALI CBS	HighPower LED	150 lm	182-B-239-00-00-01	0,6 kg
C.LEDLUX-SPOT2-B-P-DALI 230V AC	Grey / šedá	DALI CBS	HighPower LED	150 lm	182-B-239-00-00-02	0,6 kg

Page No.40

Addressable CENTRAL BATTERY (CBS) -ATXP ELMAX-PATROLUX

Type	Colour	Version	Light Source	Light Flux	Order Code	Weight
C.LEDLUX-SPOT2-B-P-ATXPR/230V AC/DC	White / biela	ATXP CBS ADDRESSABLE	HighPower LED	150 lm	182-B-221-00-00-01	0,6 kg
C.LEDLUX-SPOT2-B-P-ATXPR/230V AC/DC	Grey / šedá	ATXP CBS ADDRESSABLE	HighPower LED	150 lm	182-B-221-00-00-02	0,6 kg

Look up pages No. 210-217 for 1lx Spacing tables
Pozri str.210-217 pre rozmiestnenie svetidiel na dosiahnutie 1lx