

# lanterne grandi

big lanterns  
die grossen Laternen  
grandes  
farolas grandes

**Struttura:** alluminio a gravità, pressofuso ed estruso

**Diffusore:** in vetro soffiato, vetro a lastra. A richiesta globo in PMMA e diffusori in PC

**Lampada:** incandescenza, compatte integrate e a scarica

**Viteria:** inox

**Cablaggio:** portalampade porcellana E27, fili in teflon, morsettiera in nylon.

A richiesta accessori per lampade a scarica

**Trattamento:** anticorrosivo, elettroforesi catodica

**Verniciatura:** polveri poliesteri

**Applicazione:** a muro con piastra di fissaggio, a soffitto, a palo singola e gruppi

**Design:** Sergio Sartoni

**Structure:** gravity diecast aluminium, diecast and extruded aluminium

**Diffuser:** blown glass or panel glass. PMMA globe and PC panels available

**Bulb:** incandescent, integrated compact, discharge lamps

**Fasteners:** stainless steel

**Wiring:** E27 porcelain lampholder, teflon covered wires, nylon terminal block. Accessories for discharge

lamps available

**Coating:** anti-corrosion, cathodic electrophoretic

**Paint finish:** polyester powder

**Applications:** wall-mounted with box and fixing screws, ceiling-mounted, single or multiple for posts

**Struktur:** Aluminium-Schwerkraftguss und -druckguss, gepresstes Aluminium

**Diffusor:** geblasenes Glas oder Glasscheiben. PMMA-Kugel und PC-Scheiben verfügbar

**Lampe:** Glühlampen, kompakt integriert, Metaldampflampen

**Schrauben:** Edelstahl







**Verkabelung:** Porzellan-Lampenfassung E27, Teflonleitungen, Klemmleiste aus Nylon. Metaldampflampenzubehör

verfügbar

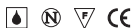
**Behandlung:** Korrosionsschutz, kathodische Elektrophorese

**Lackierung:** Polyesterpulver

**Anwendung:** Wandinstallation mit Gehäuse und Befestigungsschrauben, Deckeninstallation, Mast-Einzeleuchte oder -gruppen

IP23  CE  
 max. 200W, E27  
 Classe I  
 IP20 art. a catena  
 IP44 con fondello chiuso "R"  
 GLS   
 FL 26W   
 MVL-SB 160W   
 MVL 50/80/125W   
 MH 70/100W   
 HPS 50/70/110W 

*Struttura - Surface finish*

*Gehäuse - Monture - Estructura*



*Diffusore - Diffuser*

*Diffusor - Diffuseur - Difusor*



*PC*



**Structure:** aluminium à gravité, moulé sous pression et extrudé  
**Diffuseur:** verre soufflé ou plaque. Boule PMMA et plaque PC sur demande  
**Ampoule:** à incandescence, compactes intégrées, lampes à décharge  
**Vis:** inox  
**Câblage:** douille porcelaine E27, fils téflon, bornier nylon. Accessoires pour lampes à décharge sur demande  
**Traitement:** anticorrosion, électroforèse cathodique  
**Peinture:** poudres polyester  
**Application:** murale avec boîtier et vis de fixation, plafonnier, lanterne individuelle ou groupes pour fûts

**Estructura:** aluminio por gravedad y fundido a presión, extrusión de aluminio  
**Difusor:** vidrio soplado o laminado. Globo PMMA y PC laminado sobre pedido  
**Bombilla:** incandescencia, compactas integradas, lámparas de descarga  
**Tornillería:** inox  
**Cableado:** portalámparas porcelana E27, hilos con teflon, bornera en nylon. Accesorios para lámparas de descarga sobre pedido  
**Tratamiento:** anticorrosivo, electroforesis catódica  
**Pintado:** polvos poliésteres  
**Aplicación:** en pared, con caja y tornillos de fijación, plafón, farolas solas o grupos para báculos





mod. 90

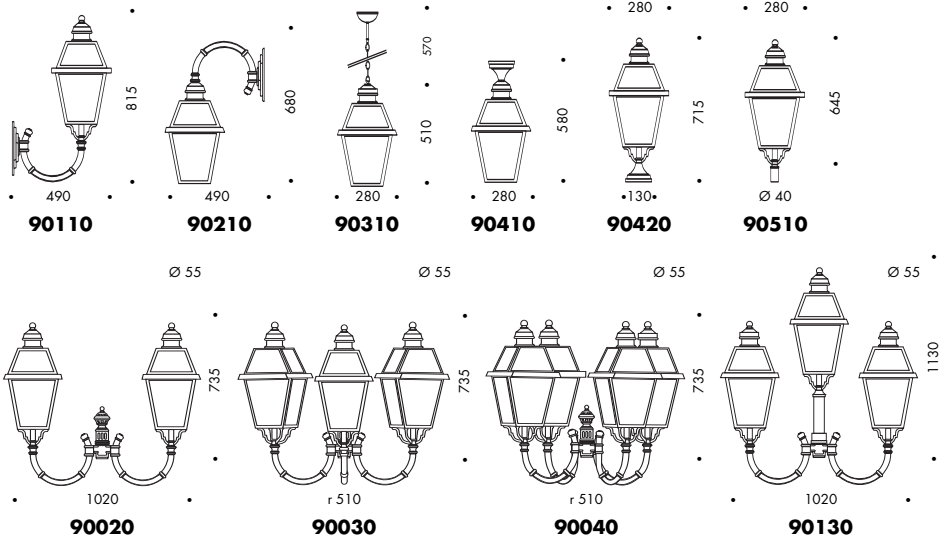

mod. 90

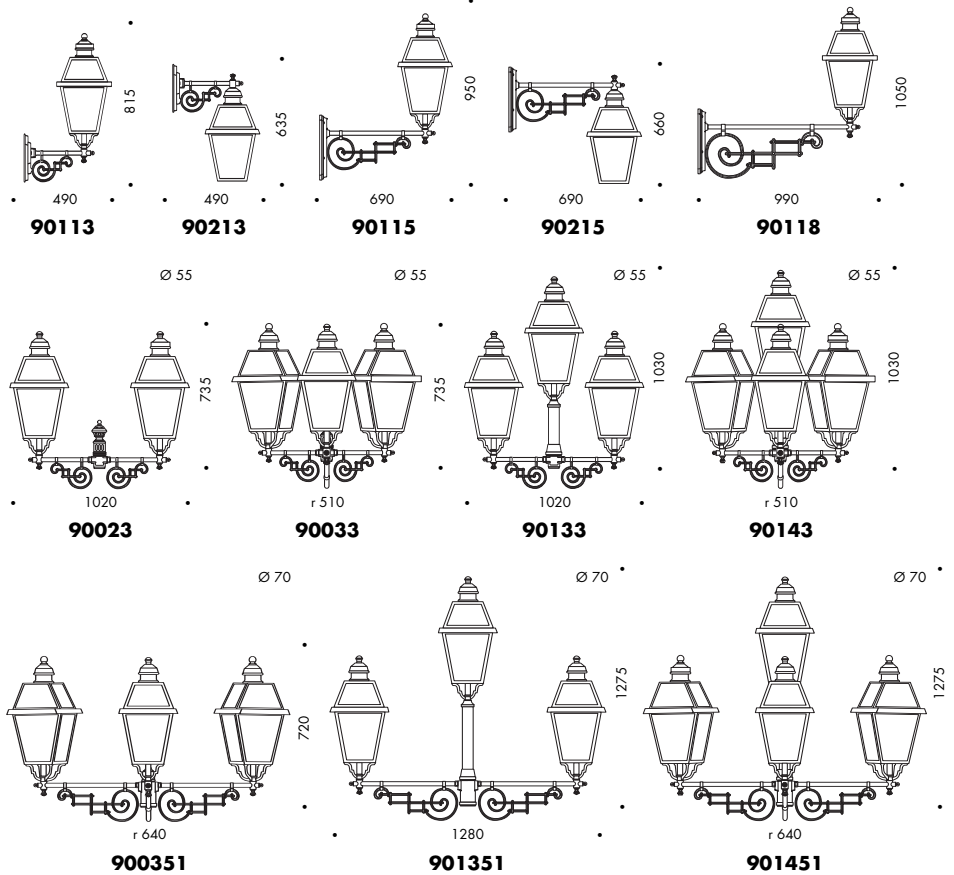

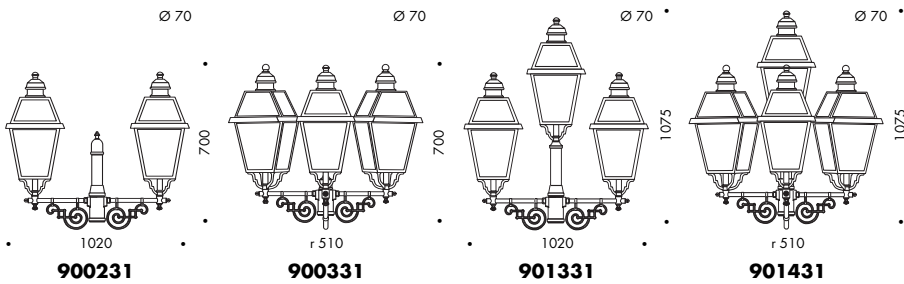
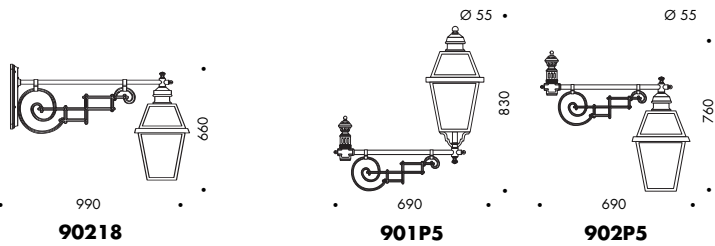
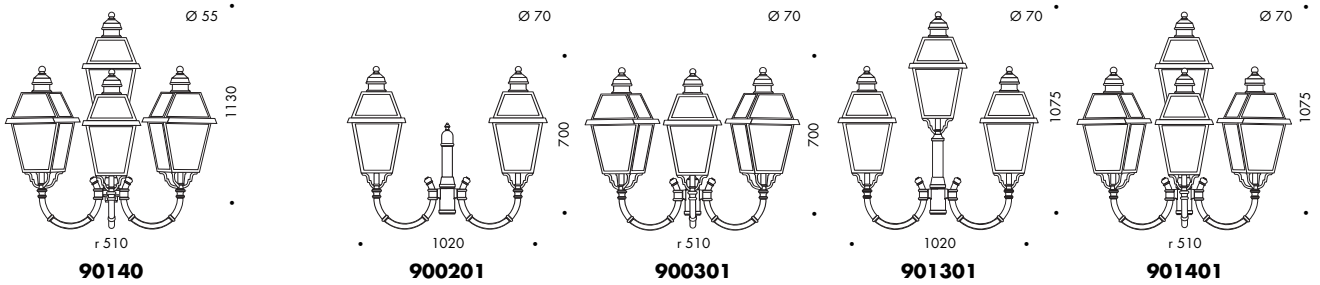
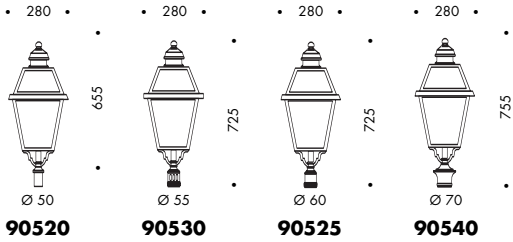

Tutti i gruppi possono essere adattati a pali aventi terminale di  $\varnothing$  55 mm.  
 Alcune applicazioni possibili sono state suggerite in base al rapporto estetico tra l'altezza del palo e la grandezza del gruppo ottico.  
 I modelli sono intercambiabili, per una migliore comprensione delle composizioni abbiamo esemplificato usando il modello 90.  
 E' possibile avere gli stessi gruppi ottici con i modelli 91/92/93/94/95.  
 Sorgenti luminose a pagina 106.

IP23 (IP44 con lampade a scarica o con accessorio R)     max. 200W E27 Classe I

 GLS  FL 23W  MVL-SB 160W  MVL 50/80/125W  MH 70/100W  HPS 50/70/110W

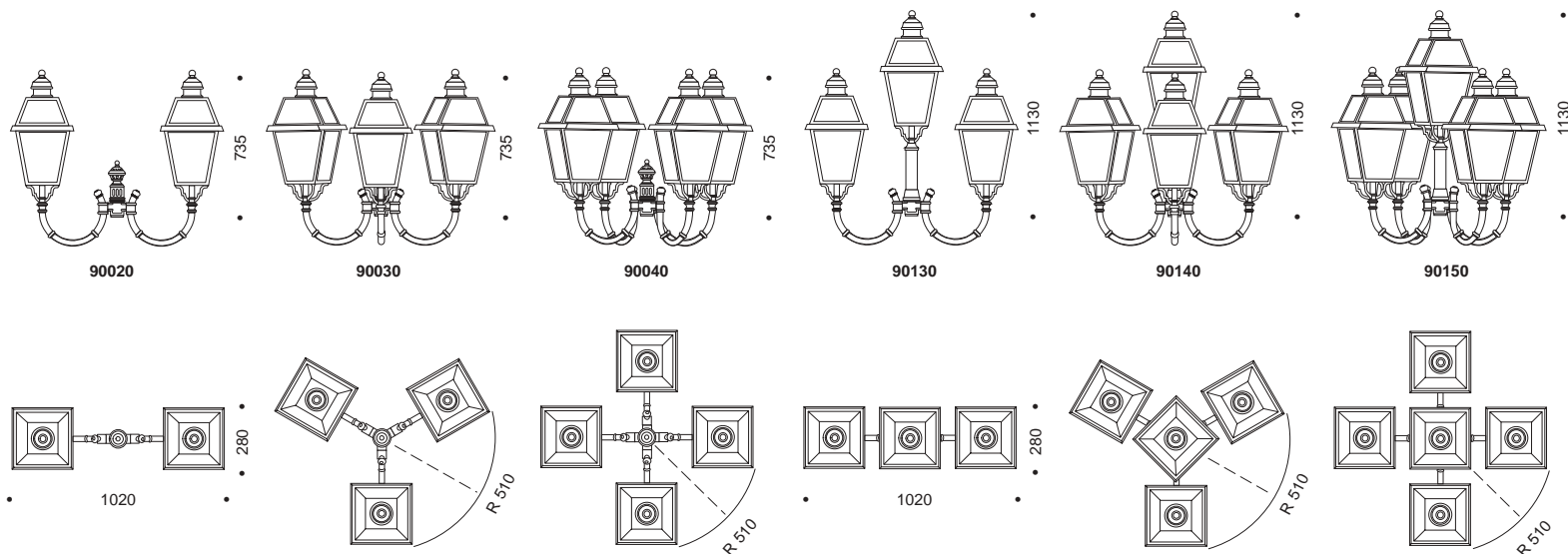

Big lantern groups can be set on posts having a fixing lantern housing of  $\varnothing$  55 mm.  
 Heads are interchangeable, for a better comprehension we suggested model 90 but arrangements are available with all models 91/92/93/94/95.  
 Clear and milky polycarbonate lens are available.  
 IP44 rate accessories and light sources page 106.

Die Grosse Laternen-Gruppe können für alle Maste mit einem Durchmesser von  $\varnothing$  55 mm verwendet werden.  
 Im Katalog haben wir zur Vereinfachung die Modelle 90, als Beispiel, abgebildet. Es können jedoch auch die Modelle 91/92/93/94/95 verwendet werden.  
 Auf Anfrage sind klare und opal polycarbonatshirme erhältlich.  
 Das Zubehör, Schutzart IP44 und andere Lichtquellen siehe Seite 106.

Nous vous présentons quelques applications possibles par rapport à l'esthétique entre la hauteur du fût et la grandeur des têtes.  
 Tous ces groupes peuvent s'adapter aux fûts de  $\varnothing$  55 mm.  
 Les modèles sont interchangeables, pour simplifier nous avons présenté le modèle 90 mais la même application peut se faire avec les modèles 91/92/93/94/95.  
 Diffuseurs en polycarbonate transparent et opal sont disponibles.  
 Accessoires IP44 et sources lumineuses page 106.

Hemos sugerido algunas aplicaciones posibles basándonos en la relación estética entre la altura del báculo y el tamaño del grupo óptico.  
 Todos los grupos pueden ser adaptados a báculos que tengan una junta de  $\varnothing$  55 mm.  
 Los modelos son intercambiables.  
 Para una mejor comprensión de las composiciones, hemos realizado un ejemplo con el modelo 90. Es posible tener los mismos grupos ópticos con los modelos 91/92/93/94/95.  
 Disponibles difusores en policarbonato transparente y opal.  
 Accesorios IP44 y fuentes luminosas página 106.

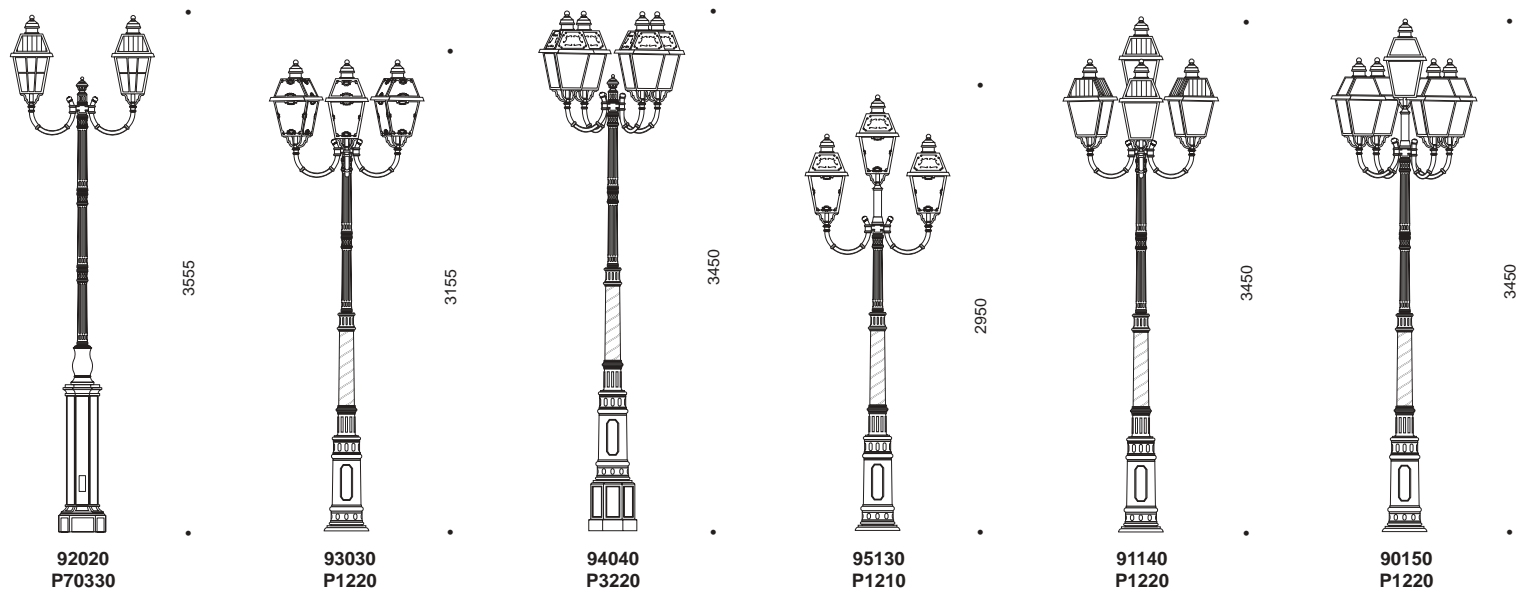

Gruppi da utilizzare esclusivamente con pali della serie *Via Publica* aventi terminale di  $\varnothing$  70 mm.  
 Alcune applicazioni possibili sono state suggerite in base al rapporto estetico tra l'altezza del palo e la grandezza del gruppo ottico.  
 I modelli sono intercambiabili, per una migliore comprensione delle composizioni abbiamo esemplificato usando il modello 90.  
 E' possibile avere gli stessi gruppi ottici con i modelli 91/92/93/94/95.  
 Sorgenti luminose a pagina 106.

IP23 (IP44 con lampade a scarica o con accessorio R)    max. 200W E27 Classe I

 GLS  FL 23W  MVL-SB 160W  MVL 50/80/125W  MH 70/100W  HPS 50/70/110W

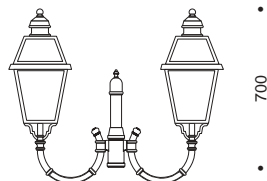

900201



900301

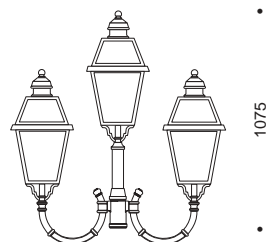

901301

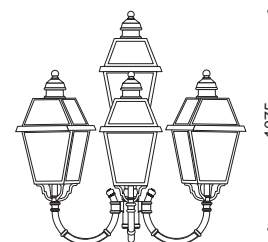

901401

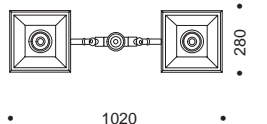

1020

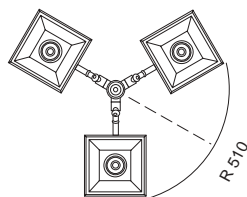

R 510

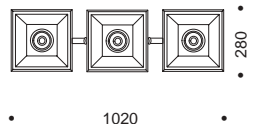

1020

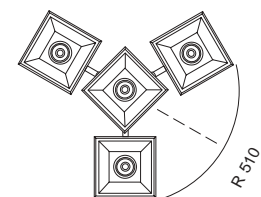

R 510

Big lantern groups can be set on posts having a fixing lantern housing of  $\varnothing$  70 mm.  
 Heads are interchangeable, for a better comprehension we suggested model 90 but arrangements are available with all models 91/92/93/94/95.  
 Clear and milky polycarbonate lens are available.  
 IP44 rate accessories and light sources page 106.

Die Grosse Laternen-Gruppe können für alle Maste mit einem Durchmesser von  $\varnothing$  70 mm verwendet werden.  
 Im Katalog haben wir zur Vereinfachung die Modelle 90, als Beispiel, abgebildet. Es können jedoch auch die Modelle 91/92/93/94/95 verwendet werden.  
 Auf Anfrage sind klare und opal polycarbonatshirme erhältlich.  
 Das Zubehör, Schutzart IP44 und andere Lichtquellen siehe Seite 106.

Nous vous présentons quelques applications possibles par rapport à l'esthétique entre la hauteur du fût et la grandeur des têtes. Tous ces groupes peuvent s'adapter aux fûts de  $\varnothing$  70 mm.  
 Les modèles sont interchangeables, pour simplifier nous avons présenté le modèle 90 mais la même application peut se faire avec les modèles 91/92/93/94/95.  
 Diffuseurs en polycarbonate transparent et opal sont disponibles.  
 Accessoires IP44 et sources lumineuses page 106.

Hemos sugerido algunas aplicaciones posibles basándonos en la relación estética entre la altura del báculo y el tamaño del grupo óptico.  
 Todos los grupos pueden ser adaptados a báculos que tengan una junta de  $\varnothing$  70 mm.  
 Los modelos son intercambiables. Para una mejor comprensión de las composiciones, hemos realizado un ejemplo con el modelo 90. Es posible tener los mismos grupos ópticos con los modelos 91/92/93/94/95.  
 Disponibles difusores en policarbonato transparente y opal.  
 Accesorios IP44 y fuentes luminosas página 106.

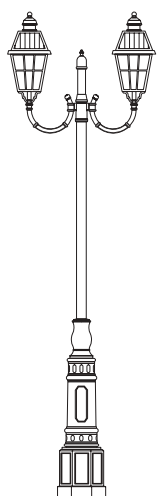

920201  
P30070

3550

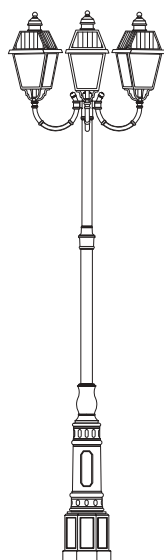

910301  
P30097

3950

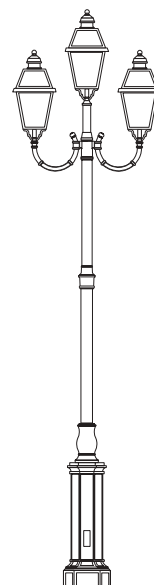

901301  
P70297

4175

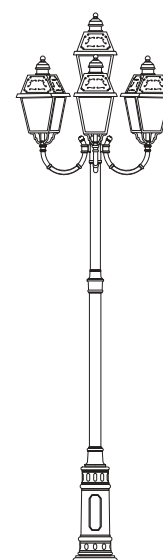

941401  
P11097

4025

Tutti i gruppi possono essere adattati a pali aventi terminale di  $\varnothing$  55 mm.  
 Alcune applicazioni possibili sono state suggerite in base al rapporto estetico tra l'altezza del palo e la grandezza del gruppo ottico.  
 I modelli sono intercambiabili, per una migliore comprensione delle composizioni abbiamo esemplificato usando il modello 90.  
 E' possibile avere gli stessi gruppi ottici con i modelli 91/92/93/94/95.  
 Sorgenti luminose a pagina 106.

IP23 (IP44 con lampade a scarica o con accessorio R)     max. 200W E27 Classe I

 GLS  FL 23W  MVL-SB 160W  MVL 50/80/125W  MH 70/100W  HPS 50/70/110W

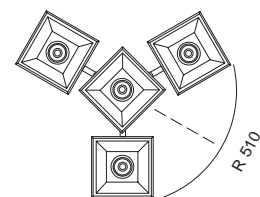
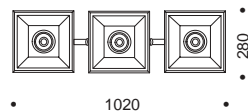
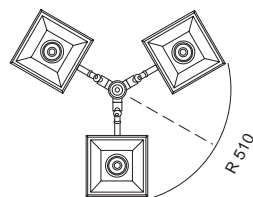
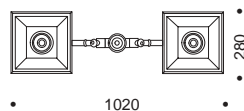
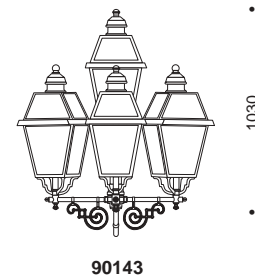
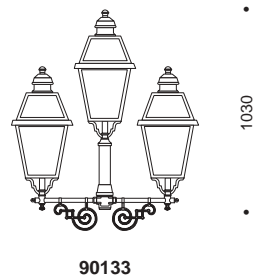
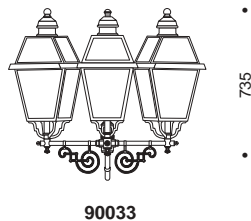
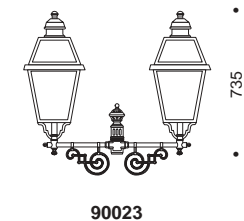

Big lantern groups can be set on posts having a fixing lantern housing of  $\varnothing$  55 mm.  
 Heads are interchangeable, for a better comprehension we suggested model 90 but arrangements are available with all models 91/92/93/94/95.  
 Clear and milky polycarbonate lens are available.  
 IP44 rate accessories and light sources page 106.

Die Grosse Laternen-Gruppe können für alle Maste mit einem Durchmesser von  $\varnothing$  55 mm verwendet werden.  
 Im Katalog haben wir zur Vereinfachung die Modelle 90, als Beispiel, abgebildet. Es können jedoch auch die Modelle 91/92/93/94/95 verwendet werden.  
 Auf Anfrage sind klare und opal polycarbonatshirme erhältlich.  
 Das Zubehör, Schutzart IP44 und andere Lichtquellen siehe Seite 106.

Nous vous présentons quelques applications possibles par rapport à l'esthétique entre la hauteur du fût et la grandeur des têtes.  
 Tous ces groupes peuvent s'adapter aux fûts de  $\varnothing$  55 mm.  
 Les modèles sont interchangeables, pour simplifier nous avons présenté le modèle 90 mais la même application peut se faire avec les modèles 91/92/93/94/95.  
 Diffuseurs en polycarbonate transparent et opal sont disponibles.  
 Accessoires IP44 et sources lumineuses page 106.

Hemos sugerido algunas aplicaciones posibles basándonos en la relación estética entre la altura del báculo y el tamaño del grupo óptico.  
 Todos los grupos pueden ser adaptados a báculos que tengan una junta de  $\varnothing$  55 mm.  
 Los modelos son intercambiables. Para una mejor comprensión de las composiciones, hemos realizado un ejemplo con el modelo 90. Es posible tener los mismos grupos ópticos con los modelos 91/92/93/94/95.  
 Disponibles difusores en policarbonato transparente y opal.  
 Accesorios IP44 y fuentes luminosas página 106.

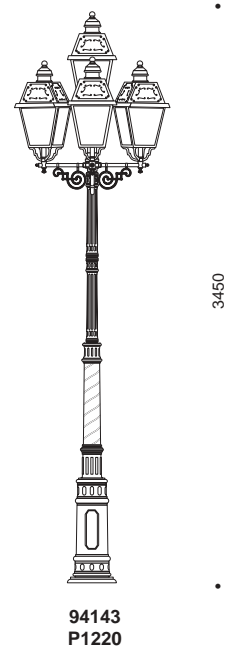
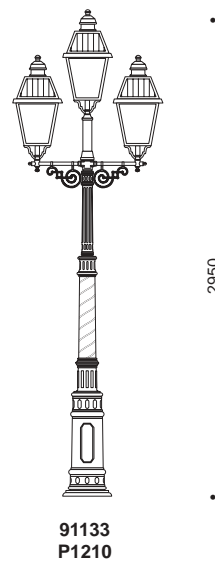
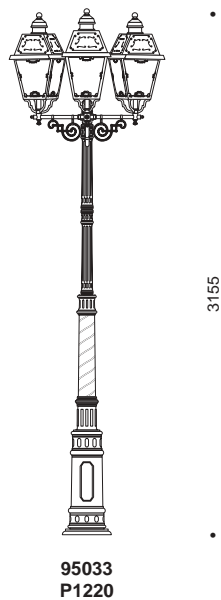
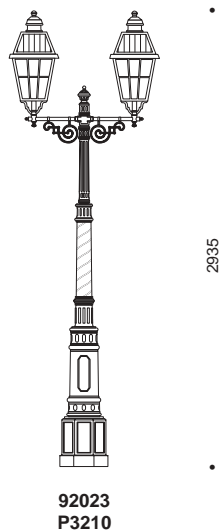

Gruppi da utilizzare esclusivamente con pali della serie *Via Publica* aventi terminale di  $\varnothing$  70 mm.  
 Alcune applicazioni possibili sono state suggerite in base al rapporto estetico tra l'altezza del palo e la grandezza del gruppo ottico.  
 I modelli sono intercambiabili, per una migliore comprensione delle composizioni abbiamo esemplificato usando il modello 90.  
 E' possibile avere gli stessi gruppi ottici con i modelli 91/92/93/94/95.  
 Sorgenti luminose a pagina 106.

IP23 (IP44 con lampade a scarica o con accessorio R)     max. 200W E27 Classe I

 GLS  FL 23W  MVL-SB 160W  MVL 50/80/125W  MH 70/100W  HPS 50/70/110W

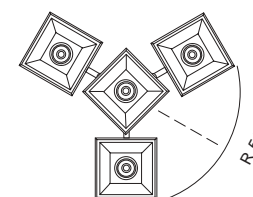
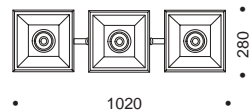
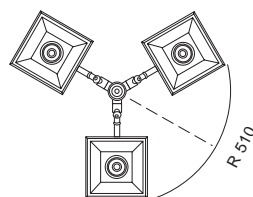
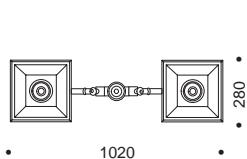
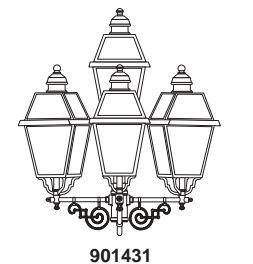
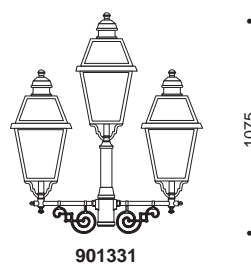
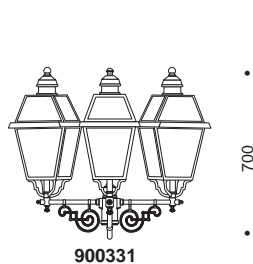
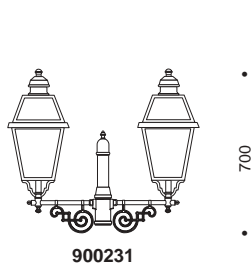

Big lantern groups can be set on posts having a fixing lantern housing of  $\varnothing$  70 mm.  
 Heads are interchangeable, for a better comprehension we suggested model 90 but arrangements are available with all models 91/92/93/94/95.  
 Clear and milky polycarbonate lens are available.  
 IP44 rate accessories and light sources page 106.

Die Grosse Laternen-Gruppe können für alle Maste mit einem Durchmesser von  $\varnothing$  70 mm verwendet werden.  
 Im Katalog haben wir zur Vereinfachung die Modelle 90, als Beispiel, abgebildet. Es können jedoch auch die Modelle 91/92/93/94/95 verwendet werden.  
 Auf Anfrage sind klare und opal polycarbonatshirme erhältlich.  
 Das Zubehör, Schutzart IP44 und andere Lichtquellen siehe Seite 106.

Nous vous présentons quelques applications possibles par rapport à l'esthétique entre la hauteur du fût et la grandeur des têtes.  
 Tous ces groupes peuvent s'adapter aux fûts de  $\varnothing$  70 mm.  
 Les modèles sont interchangeables, pour simplifier nous avons présenté le modèle 90 mais la même application peut se faire avec les modèles 91/92/93/94/95.  
 Diffuseurs en polycarbonate transparent et opal sont disponibles.  
 Accessoires IP44 et sources lumineuses page 106.

Hemos sugerido algunas aplicaciones posibles basándonos en la relación estética entre la altura del báculo y el tamaño del grupo óptico.  
 Todos los grupos pueden ser adaptados a báculos que tengan una junta de  $\varnothing$  70 mm.  
 Los modelos son intercambiables. Para una mejor comprensión de las composiciones, hemos realizado un ejemplo con el modelo 90. Es posible tener los mismos grupos ópticos con los modelos 91/92/93/94/95.  
 Disponibles difusores en policarbonato transparente y opal.  
 Accesorios IP44 y fuentes luminosas página 106.

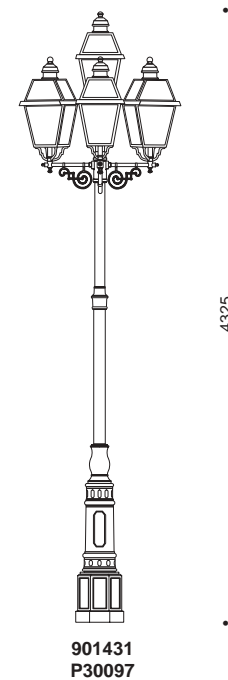
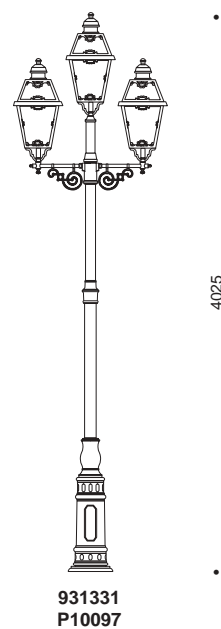
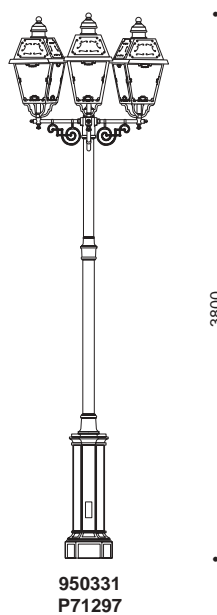
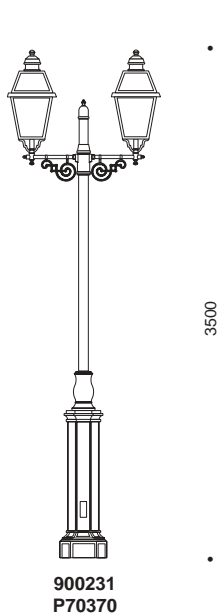



Gruppi da utilizzare esclusivamente con pali della serie *Via Publica* aventi terminale di  $\varnothing$  70 mm.  
 Alcune applicazioni possibili sono state suggerite in base al rapporto estetico tra l'altezza del palo e la grandezza del gruppo ottico.  
 I modelli sono intercambiabili, per una migliore comprensione delle composizioni abbiamo esemplificato usando il modello 90.  
 E' possibile avere gli stessi gruppi ottici con i modelli 91/92/93/94/95.  
 Sorgenti luminose a pagina 106.

IP23 (IP44 con lampade a scarica o con accessorio R)  $\triangle$   $\text{N}$   $\nabla$   $\text{C}$  max. 200W E27 Classe I

GLS FL 23W MVL-SB 160W MVL 50/80/125W MH 70/100W HPS 50/70/110W

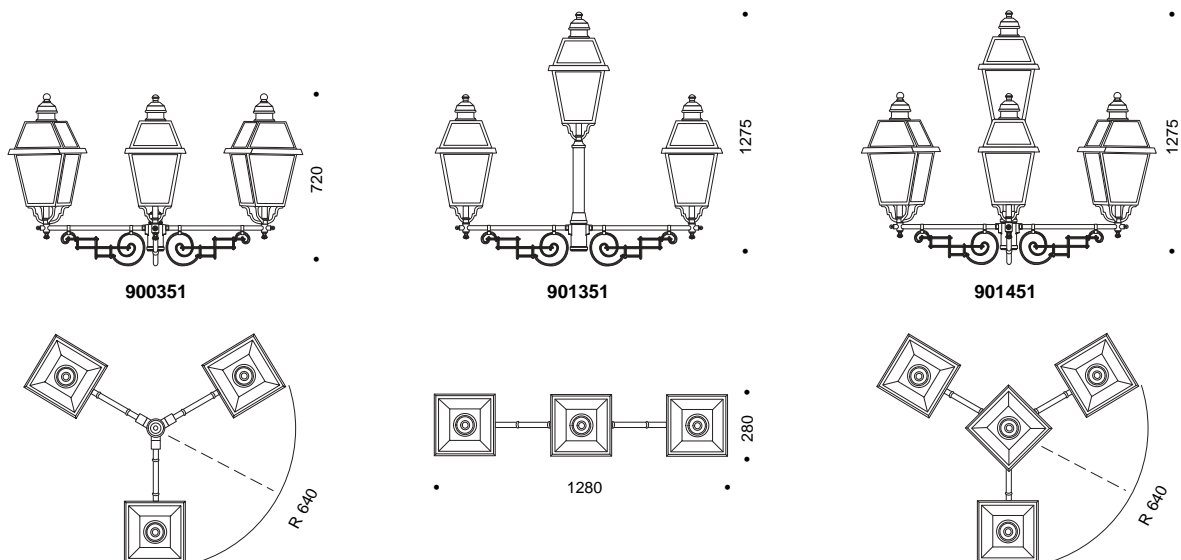

Big lantern groups can be set on posts having a fixing lantern housing of  $\varnothing$  70 mm.  
 Heads are interchangeable, for a better comprehension we suggested model 90 but arrangements are available with all models 91/92/93/94/95.  
 Clear and milky polycarbonate lens are available.  
 IP44 rate accessories and light sources page 106.

Die Grosse Laternen-Gruppe können für alle Maste mit einem Durchmesser von  $\varnothing$  70 mm verwendet werden.  
 Im Katalog haben wir zur Vereinfachung die Modelle 90, als Beispiel, abgebildet. Es können jedoch auch die Modelle 91/92/93/94/95 verwendet werden.  
 Auf Anfrage sind klare und opal polycarbonatshirme erhältlich.  
 Das Zubehör, Schutzart IP44 und andere Lichtquellen siehe Seite 106.

Nous vous présentons quelques applications possibles par rapport à l'esthétique entre la hauteur du fût et la grandeur des têtes. Tous ces groupes peuvent s'adapter aux fûts de  $\varnothing$  70 mm. Les modèles sont interchangeables, pour simplifier nous avons présenté le modèle 90 mais la même application peut se faire avec les modèles 91/92/93/94/95. Diffuseurs en polycarbonate transparent et opal sont disponibles. Accessoires IP44 et sources lumineuses page 106.

Hemos sugerido algunas aplicaciones posibles basándonos en la relación estética entre la altura del báculo y el tamaño del grupo óptico. Todos los grupos pueden ser adaptados a báculos que tengan una junta de  $\varnothing$  70 mm. Los modelos son intercambiables. Para una mejor comprensión de las composiciones, hemos realizado un ejemplo con el modelo 90. Es posible tener los mismos grupos ópticos con los modelos 91/92/93/94/95. Disponibles difusores en polycarbonato transparente y opal. Accesorios IP44 y fuentes luminosas página 106.

