

lanterne grandi

big lanterns
die grossen Laternen
grandes
farolas grandes

Struttura: alluminio a gravità, pressofuso ed estruso

Diffusore: in vetro soffiato, vetro a lastra. A richiesta globo in PMMA e diffusori in PC

Lampada: incandescenza, compatte integrate e a scarica

Viteria: inox

Cablaggio: portalampade porcellana E27, fili in teflon, morsetti in nylon.

A richiesta accessori per lampade a scarica

Trattamento: anticorrosivo, elettroforesi catodica

Verniciatura: polveri poliesteri

Applicazione: a muro con piastra di fissaggio, a soffitto, a palo singola e gruppi

Design: Sergio Sartoni

Structure: gravity diecast aluminium, diecast and extruded aluminium

Diffuser: blown glass or panel glass. PMMA globe and PC panels available

Bulb: incandescent, integrated compact, discharge lamps

Fasteners: stainless steel

Wiring: E27 porcelain lampholder, teflon covered wires, nylon terminal block. Accessories for discharge lamps available

Coating: anti-corrosion, cathodic electrophoretic

Paint finish: polyester powder

Applications: wall-mounted with box and fixing screws, ceiling-mounted, single or multiple for posts

Struktur: Aluminium-Schwerkraftguss und -druckguss, gepresstes Aluminium

Diffusor: geblasenes Glas oder Glasscheiben. PMMA-Kugel und PC-Scheiben verfügbar

Lampe: Glühlampen, kompakt integriert, Metaldampflampen







Schrauben: Edelstahl

Verkabelung: Porzellan-Lampenfassung E27, Teflonleitungen, Klemmleiste aus Nylon. Metaldampflampenzubehör verfügbar

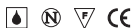
Behandlung: Korrosionsschutz, kathodische Elektrophorese

Lackierung: Polyesterpulver

Anwendung: Wandinstallation mit Gehäuse und Befestigungsschrauben, Deckeninstallation, Mast-Einzeleuchte oder -gruppen

IP23  CE
 max. 200W, E27
 Classe I
 IP20 art. a catena
 IP44 con fondello chiuso "R"
 GLS 
 FL 26W 
 MVL-SB 160W 
 MVL 50/80/125W 
 MH 70/100W 
 HPS 50/70/110W 

Struttura - Surface finish

Gehäuse - Monture - Estructura



Diffusore - Diffuser

Diffusor - Diffuseur - Difusor



PC



Structure: aluminium à gravité, moulé sous pression et extrudé
Diffuseur: verre soufflé ou plaque. Boule PMMA et plaque PC sur demande
Ampoule: à incandescence, compactes intégrées, lampes à décharge
Vis: inox
Câblage: douille porcelaine E27, fils téflon, bornier nylon. Accessoires pour lampes à décharge sur demande
Traitement: anticorrosion, électroforèse cathodique
Peinture: poudres polyester
Application: murale avec boîtier et vis de fixation, plafonnier, lanterne individuelle ou groupes pour fûts

Estructura: aluminio por gravedad y fundido a presión, extrusión de aluminio
Difusor: vidrio soplado o laminado. Globo PMMA y PC laminado sobre pedido
Bombilla: incandescencia, compactas integradas, lámparas de descarga
Tornillería: inox
Cableado: portalámparas porcelana E27, hilos con teflon, bornera en nylon. Accesorios para lámparas de descarga sobre pedido
Tratamiento: anticorrosivo, electroforesis catódica
Pintado: polvos poliésteres
Aplicación: en pared, con caja y tornillos de fijación, plafón, farolas solas o grupos para báculos





mod. 91

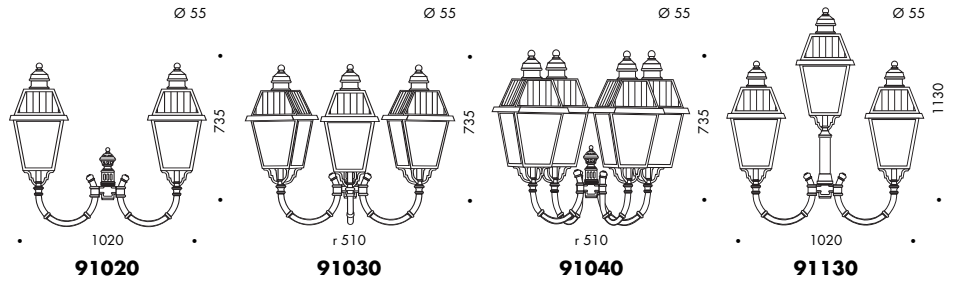
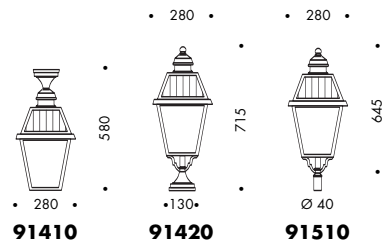
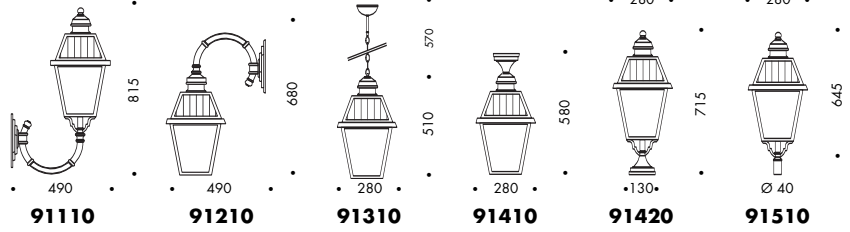

mod. 91

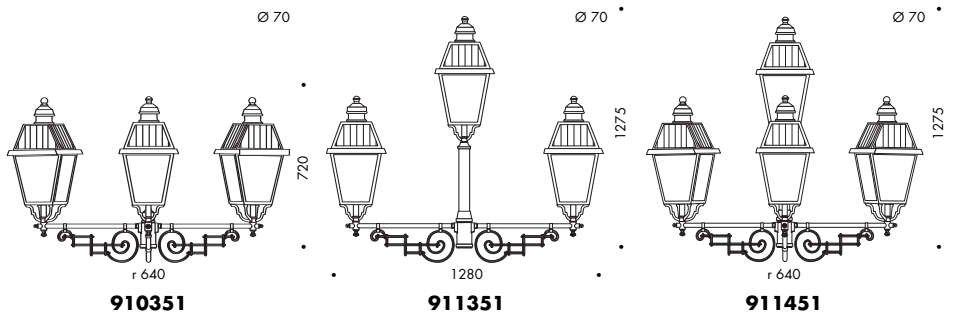
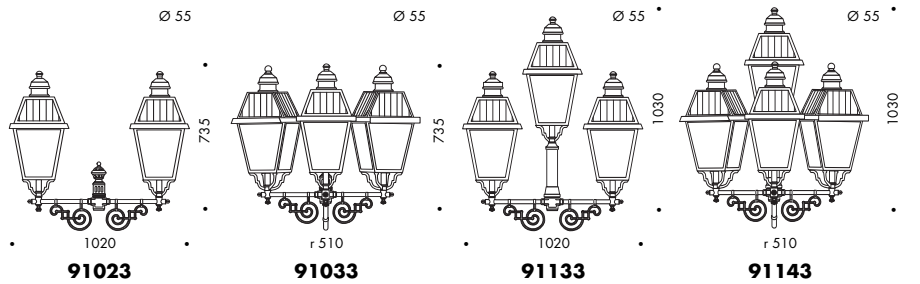
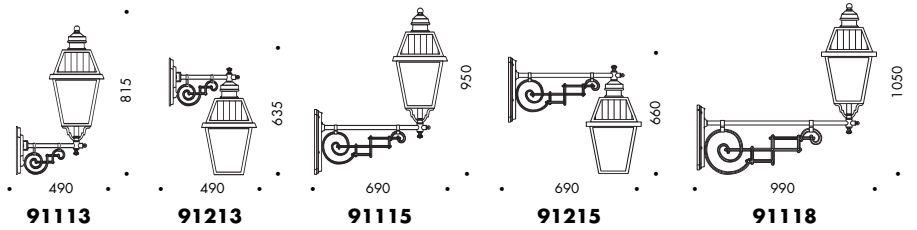

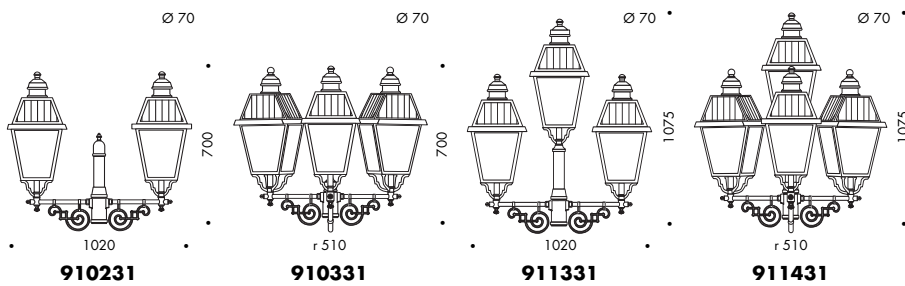
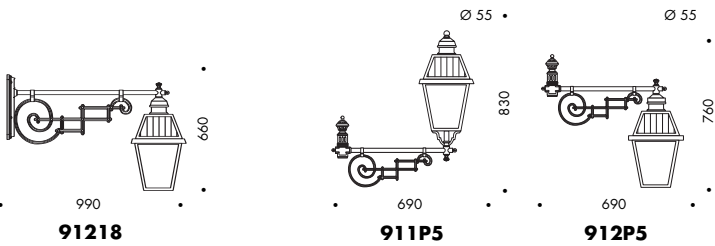
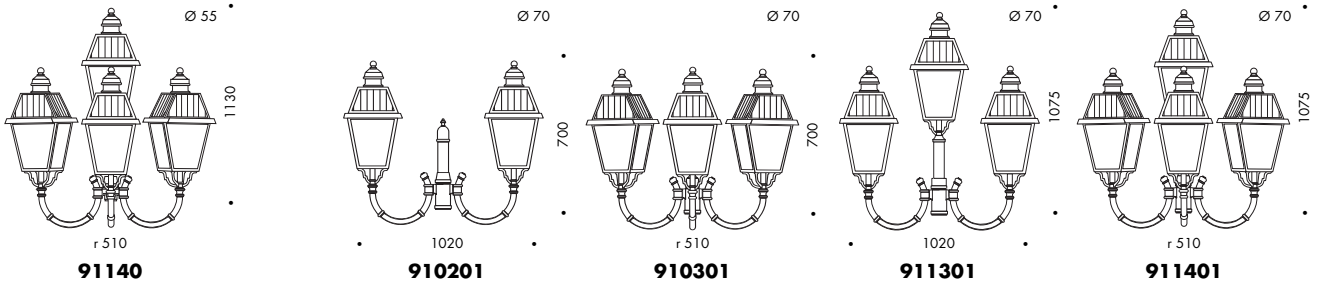
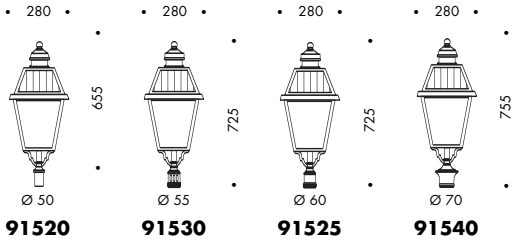

Tutti i gruppi possono essere adattati a pali aventi terminale di \varnothing 55 mm.
 Alcune applicazioni possibili sono state suggerite in base al rapporto estetico tra l'altezza del palo e la grandezza del gruppo ottico.
 I modelli sono intercambiabili, per una migliore comprensione delle composizioni abbiamo esemplificato usando il modello 90.
 E' possibile avere gli stessi gruppi ottici con i modelli 91/92/93/94/95.
 Sorgenti luminose a pagina 106.

IP23 (IP44 con lampade a scarica o con accessorio R) max. 200W E27 Classe I

GLS FL 23W MVL-SB 160W MVL 50/80/125W MH 70/100W HPS 50/70/110W

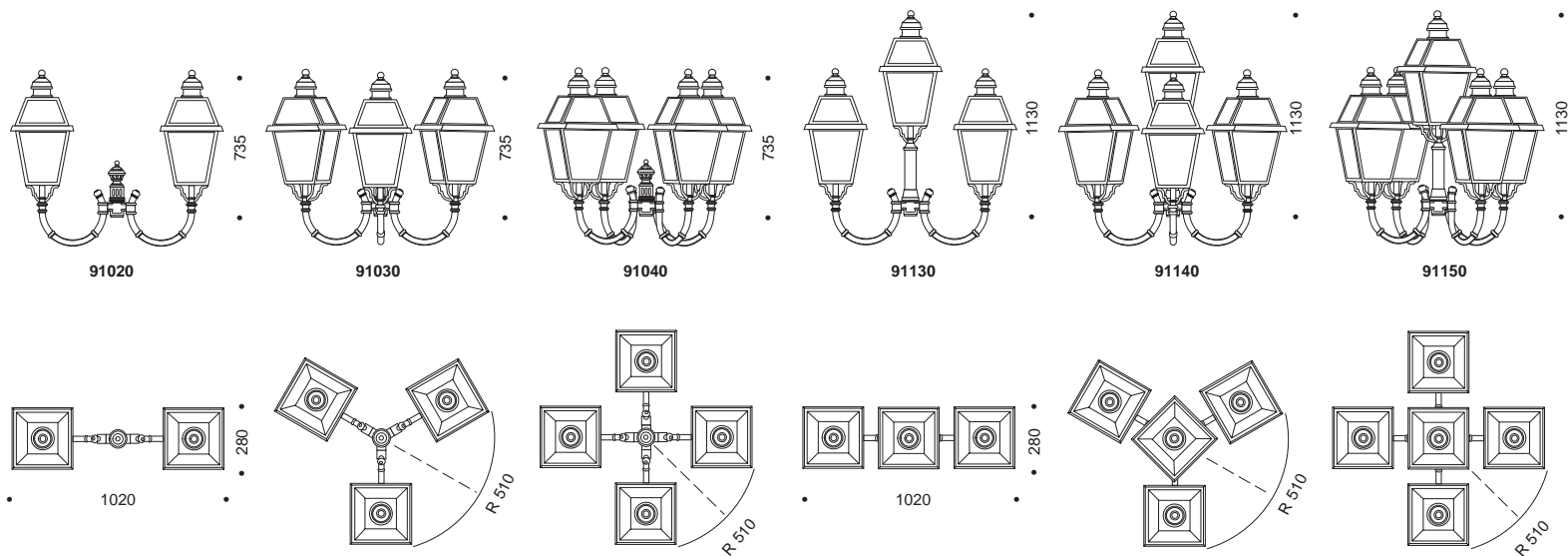

Big lantern groups can be set on posts having a fixing lantern housing of \varnothing 55 mm.
 Heads are interchangeable, for a better comprehension we suggested model 90 but arrangements are available with all models 91/92/93/94/95.
 Clear and milky polycarbonate lens are available.
 IP44 rate accessories and light sources page 106.

Die Grosse Laternen-Gruppe können für alle Maste mit einem Durchmesser von \varnothing 55 mm verwendet werden.
 Im Katalog haben wir zur Vereinfachung die Modelle 90, als Beispiel, abgebildet. Es können jedoch auch die Modelle 91/92/93/94/95 verwendet werden.
 Auf Anfrage sind klare und opal polycarbonatshirme erhältlich.
 Das Zubehör, Schutzart IP44 und andere Lichtquellen siehe Seite 106.

Nous vous présentons quelques applications possibles par rapport à l'esthétique entre la hauteur du fût et la grandeur des têtes.
 Tous ces groupes peuvent s'adapter aux fûts de \varnothing 55 mm.
 Les modèles sont interchangeables, pour simplifier nous avons présenté le modèle 90 mais la même application peut se faire avec les modèles 91/92/93/94/95.
 Diffuseurs en polycarbonate transparent et opal sont disponibles.
 Accessoires IP44 et sources lumineuses page 106.

Hemos sugerido algunas aplicaciones posibles basándonos en la relación estética entre la altura del báculo y el tamaño del grupo óptico.
 Todos los grupos pueden ser adaptados a báculos que tengan una junta de \varnothing 55 mm.
 Los modelos son intercambiables.
 Para una mejor comprensión de las composiciones, hemos realizado un ejemplo con el modelo 90. Es posible tener los mismos grupos ópticos con los modelos 91/92/93/94/95.
 Disponibles difusores en policarbonato transparente y opal.
 Accesorios IP44 y fuentes luminosas página 106.

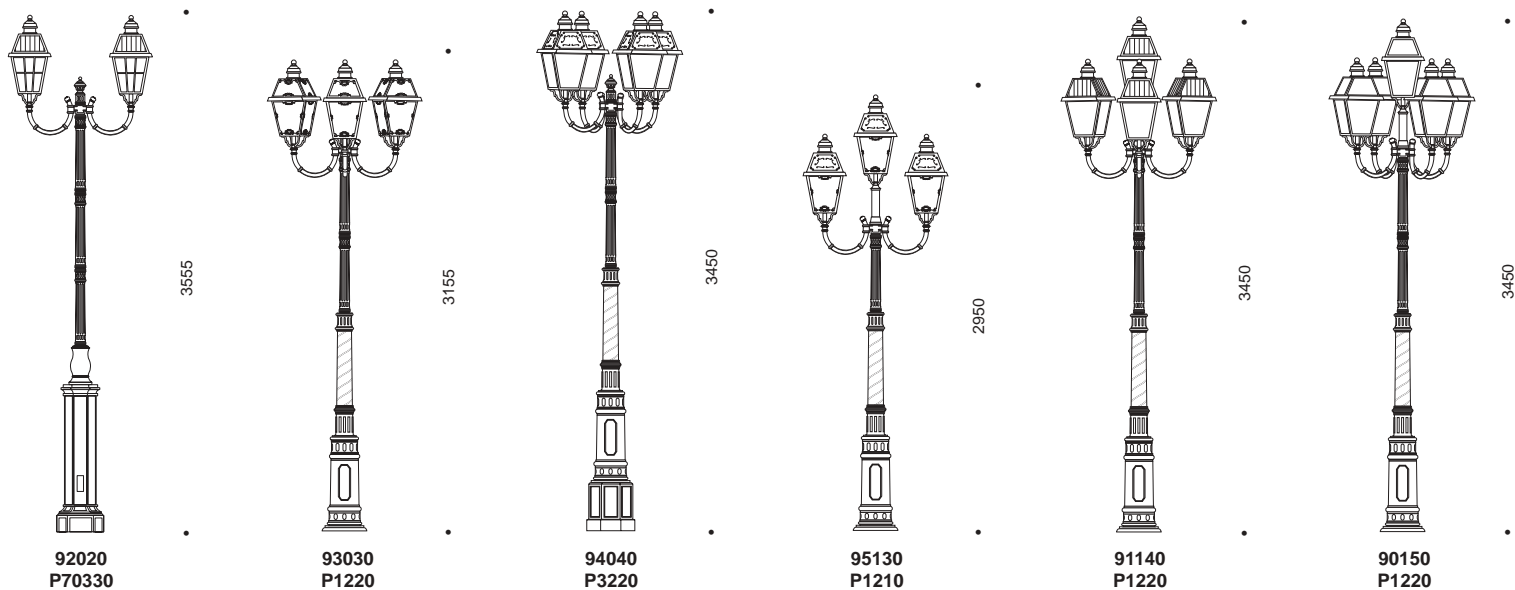

Gruppi da utilizzare esclusivamente con pali della serie *Via Publica* aventi terminale di \varnothing 70 mm.
 Alcune applicazioni possibili sono state suggerite in base al rapporto estetico tra l'altezza del palo e la grandezza del gruppo ottico.
 I modelli sono intercambiabili, per una migliore comprensione delle composizioni abbiamo esemplificato usando il modello 90.
 E' possibile avere gli stessi gruppi ottici con i modelli 91/92/93/94/95.
 Sorgenti luminose a pagina 106.

IP23 (IP44 con lampade a scarica o con accessorio R)    max. 200W E27 Classe I

 GLS  FL 23W  MVL-SB 160W  MVL 50/80/125W  MH 70/100W  HPS 50/70/110W

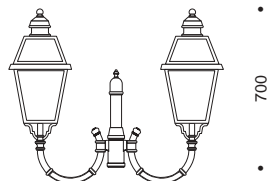

910201



910301

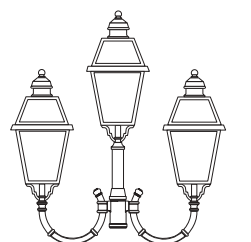

911301

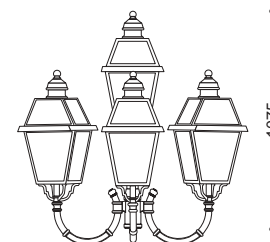

911401

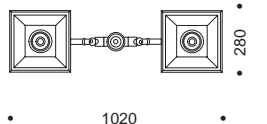

1020

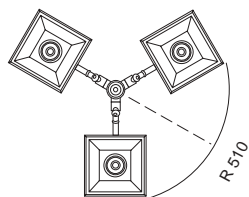

R 510

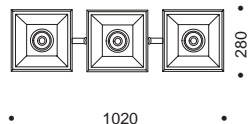

1020

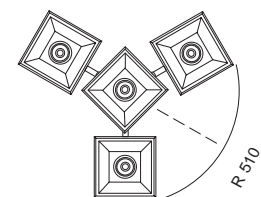

R 510

Big lantern groups can be set on posts having a fixing lantern housing of \varnothing 70 mm.
 Heads are interchangeable, for a better comprehension we suggested model 90 but arrangements are available with all models 91/92/93/94/95.
 Clear and milky polycarbonate lens are available.
 IP44 rate accessories and light sources page 106.

Die Grosse Laternen-Gruppe können für alle Maste mit einem Durchmesser von \varnothing 70 mm verwendet werden.
 Im Katalog haben wir zur Vereinfachung die Modelle 90, als Beispiel, abgebildet. Es können jedoch auch die Modelle 91/92/93/94/95 verwendet werden.
 Auf Anfrage sind klare und opal polycarbonatshirme erhältlich.
 Das Zubehör, Schutzart IP44 und andere Lichtquellen siehe Seite 106.

Nous vous présentons quelques applications possibles par rapport à l'esthétique entre la hauteur du fût et la grandeur des têtes. Tous ces groupes peuvent s'adapter aux fûts de \varnothing 70 mm.
 Les modèles sont interchangeables, pour simplifier nous avons présenté le modèle 90 mais la même application peut se faire avec les modèles 91/92/93/94/95.
 Diffuseurs en polycarbonate transparent et opal sont disponibles.
 Accessoires IP44 et sources lumineuses page 106.

Hemos sugerido algunas aplicaciones posibles basándonos en la relación estética entre la altura del báculo y el tamaño del grupo óptico.
 Todos los grupos pueden ser adaptados a báculos que tengan una junta de \varnothing 70 mm.
 Los modelos son intercambiables. Para una mejor comprensión de las composiciones, hemos realizado un ejemplo con el modelo 90. Es posible tener los mismos grupos ópticos con los modelos 91/92/93/94/95.
 Disponibles difusores en policarbonato transparente y opal.
 Accesorios IP44 y fuentes luminosas página 106.

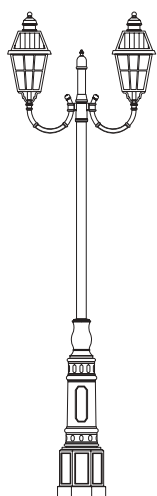

920201
P30070

3550

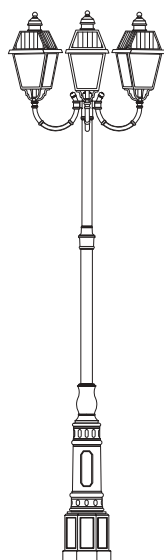

910301
P30097

3950

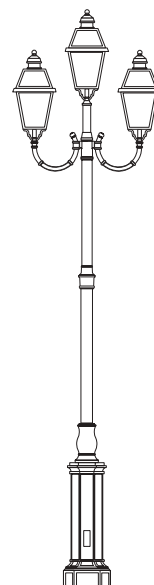

901301
P70297

4175

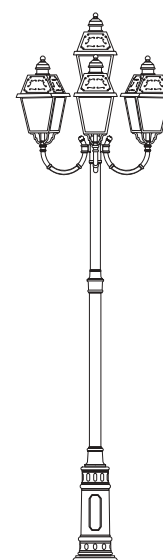

941401
P11097

4025

Tutti i gruppi possono essere adattati a pali aventi terminale di \varnothing 55 mm.
 Alcune applicazioni possibili sono state suggerite in base al rapporto estetico tra l'altezza del palo e la grandezza del gruppo ottico.
 I modelli sono intercambiabili, per una migliore comprensione delle composizioni abbiamo esemplificato usando il modello 90.
 E' possibile avere gli stessi gruppi ottici con i modelli 91/92/93/94/95.
 Sorgenti luminose a pagina 106.

IP23 (IP44 con lampade a scarica o con accessorio R)     max. 200W E27 Classe I

 GLS  FL 23W  MVL-SB 160W  MVL 50/80/125W  MH 70/100W  HPS 50/70/110W

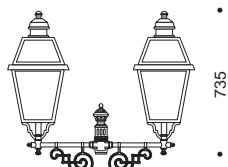

91023

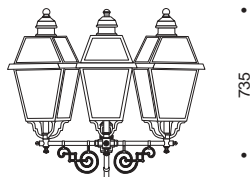

91033

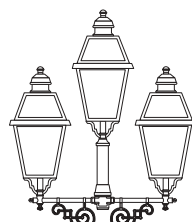

91133

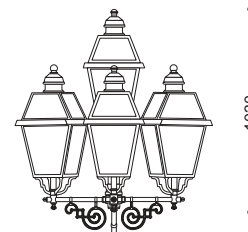

91143

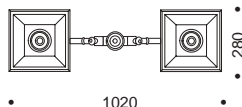

1020

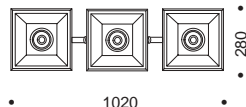
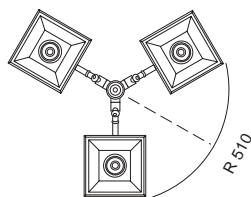

1020

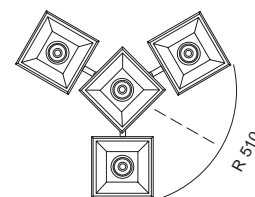

Big lantern groups can be set on posts having a fixing lantern housing of \varnothing 55 mm.
 Heads are interchangeable, for a better comprehension we suggested model 90 but arrangements are available with all models 91/92/93/94/95.
 Clear and milky polycarbonate lens are available.
 IP44 rate accessories and light sources page 106.

Die Grosse Laternen-Gruppe können für alle Maste mit einem Durchmesser von \varnothing 55 mm verwendet werden.
 Im Katalog haben wir zur Vereinfachung die Modelle 90, als Beispiel, abgebildet. Es können jedoch auch die Modelle 91/92/93/94/95 verwendet werden.
 Auf Anfrage sind klare und opal polycarbonatshirme erhältlich.
 Das Zubehör, Schutzart IP44 und andere Lichtquellen siehe Seite 106.

Nous vous présentons quelques applications possibles par rapport à l'esthétique entre la hauteur du fût et la grandeur des têtes.
 Tous ces groupes peuvent s'adapter aux fûts de \varnothing 55 mm.
 Les modèles sont interchangeables, pour simplifier nous avons présenté le modèle 90 mais la même application peut se faire avec les modèles 91/92/93/94/95.
 Diffuseurs en polycarbonate transparent et opal sont disponibles.
 Accessoires IP44 et sources lumineuses page 106.

Hemos sugerido algunas aplicaciones posibles basándonos en la relación estética entre la altura del báculo y el tamaño del grupo óptico.
 Todos los grupos pueden ser adaptados a báculos que tengan una junta de \varnothing 55 mm.
 Los modelos son intercambiables. Para una mejor comprensión de las composiciones, hemos realizado un ejemplo con el modelo 90. Es posible tener los mismos grupos ópticos con los modelos 91/92/93/94/95.
 Disponibles difusores en policarbonato transparente y opal.
 Accesorios IP44 y fuentes luminosas página 106.

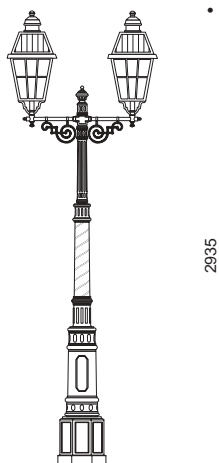

92023
P3210

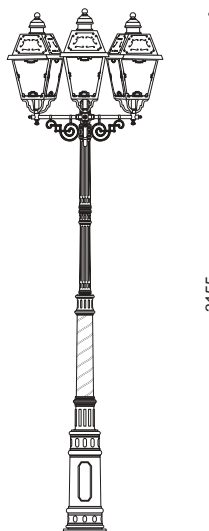

95033
P1220

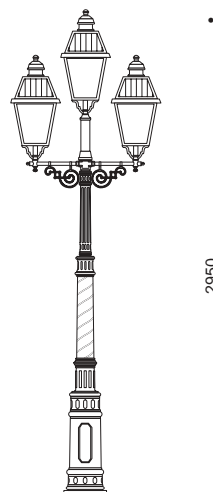

91133
P1210

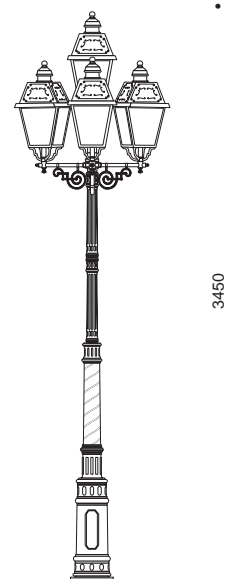

94143
P1220

Gruppi da utilizzare esclusivamente con pali della serie *Via Publica* aventi terminale di \varnothing 70 mm.
 Alcune applicazioni possibili sono state suggerite in base al rapporto estetico tra l'altezza del palo e la grandezza del gruppo ottico.
 I modelli sono intercambiabili, per una migliore comprensione delle composizioni abbiamo esemplificato usando il modello 90.
 E' possibile avere gli stessi gruppi ottici con i modelli 91/92/93/94/95.
 Sorgenti luminose a pagina 106.

IP23 (IP44 con lampade a scarica o con accessorio R)     max. 200W E27 Classe I

 GLS  FL 23W  MVL-SB 160W  MVL 50/80/125W  MH 70/100W  HPS 50/70/110W

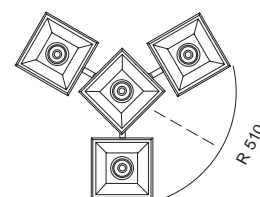
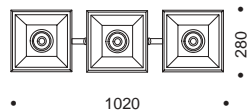
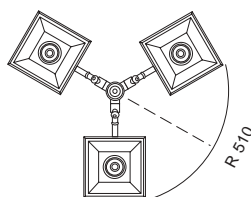
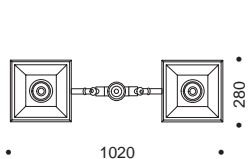
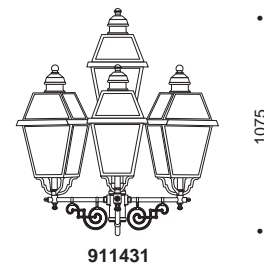
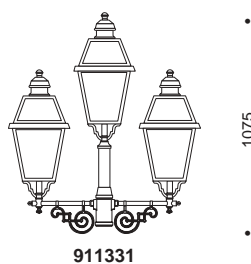
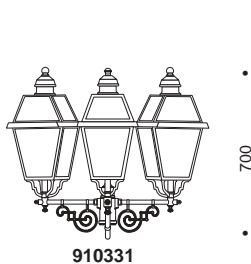
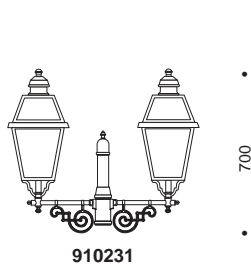

Big lantern groups can be set on posts having a fixing lantern housing of \varnothing 70 mm.
 Heads are interchangeable, for a better comprehension we suggested model 90 but arrangements are available with all models 91/92/93/94/95.
 Clear and milky polycarbonate lens are available.
 IP44 rate accessories and light sources page 106.

Die Grosse Laternen-Gruppe können für alle Maste mit einem Durchmesser von \varnothing 70 mm verwendet werden.
 Im Katalog haben wir zur Vereinfachung die Modelle 90, als Beispiel, abgebildet. Es können jedoch auch die Modelle 91/92/93/94/95 verwendet werden.
 Auf Anfrage sind klare und opal polycarbonatshirme erhältlich.
 Das Zubehör, Schutzart IP44 und andere Lichtquellen siehe Seite 106.

Nous vous présentons quelques applications possibles par rapport à l'esthétique entre la hauteur du fût et la grandeur des têtes.
 Tous ces groupes peuvent s'adapter aux fûts de \varnothing 70 mm.
 Les modèles sont interchangeables, pour simplifier nous avons présenté le modèle 90 mais la même application peut se faire avec les modèles 91/92/93/94/95.
 Diffuseurs en polycarbonate transparent et opal sont disponibles.
 Accessoires IP44 et sources lumineuses page 106.

Hemos sugerido algunas aplicaciones posibles basándonos en la relación estética entre la altura del báculo y el tamaño del grupo óptico.
 Todos los grupos pueden ser adaptados a báculos que tengan una junta de \varnothing 70 mm.
 Los modelos son intercambiables. Para una mejor comprensión de las composiciones, hemos realizado un ejemplo con el modelo 90. Es posible tener los mismos grupos ópticos con los modelos 91/92/93/94/95.
 Disponibles difusores en policarbonato transparente y opal.
 Accesorios IP44 y fuentes luminosas página 106.

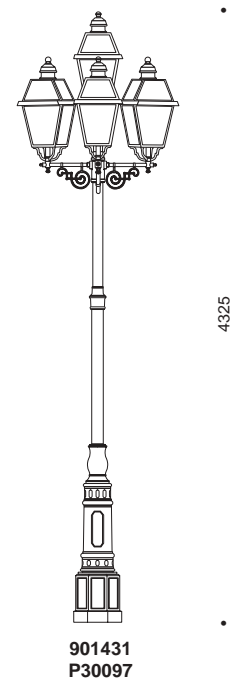
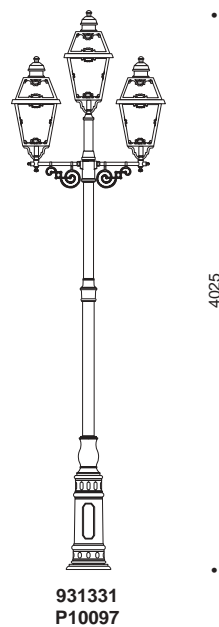
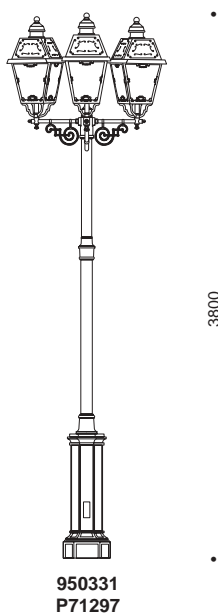
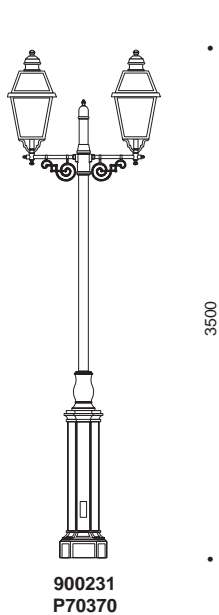

Gruppi da utilizzare esclusivamente con pali della serie *Via Publica* aventi terminale di \varnothing 70 mm.
 Alcune applicazioni possibili sono state suggerite in base al rapporto estetico tra l'altezza del palo e la grandezza del gruppo ottico.
 I modelli sono intercambiabili, per una migliore comprensione delle composizioni abbiamo esemplificato usando il modello 90.
 E' possibile avere gli stessi gruppi ottici con i modelli 91/92/93/94/95.
 Sorgenti luminose a pagina 106.

IP23 (IP44 con lampade a scarica o con accessorio R) \triangle N ∇ C max. 200W E27 Classe I

GLS FL 23W MVL-SB 160W MVL 50/80/125W MH 70/100W HPS 50/70/110W

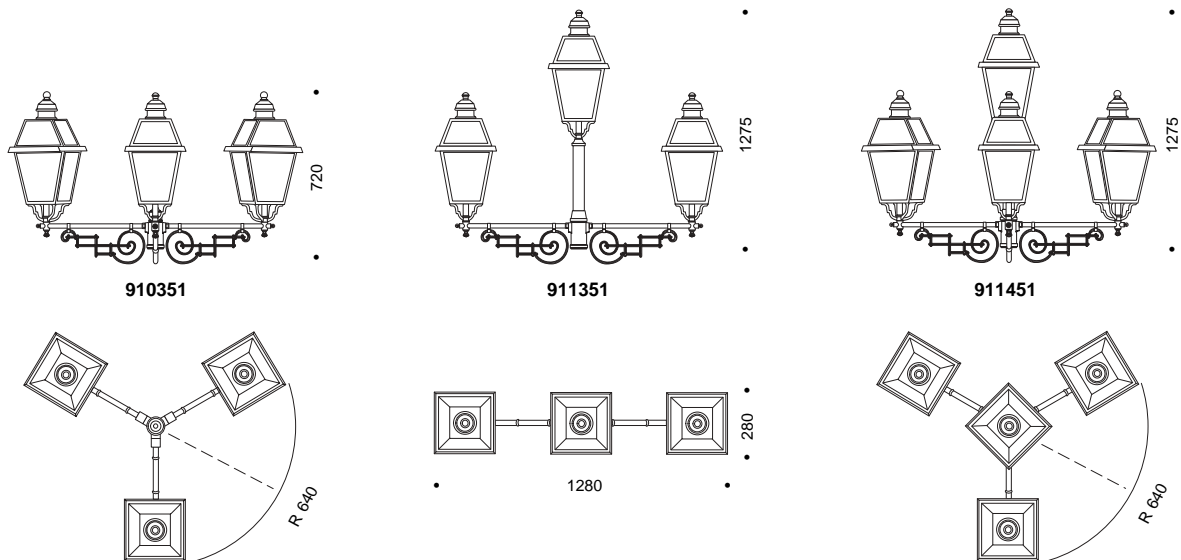

Big lantern groups can be set on posts having a fixing lantern housing of \varnothing 70 mm.
 Heads are interchangeable, for a better comprehension we suggested model 90 but arrangements are available with all models 91/92/93/94/95.
 Clear and milky polycarbonate lens are available.
 IP44 rate accessories and light sources page 106.

Die Grosse Laternen-Gruppe können für alle Maste mit einem Durchmesser von \varnothing 70 mm verwendet werden.
 Im Katalog haben wir zur Vereinfachung die Modelle 90, als Beispiel, abgebildet. Es können jedoch auch die Modelle 91/92/93/94/95 verwendet werden.
 Auf Anfrage sind klare und opal polycarbonatshirme erhältlich.
 Das Zubehör, Schutzart IP44 und andere Lichtquellen siehe Seite 106.

Nous vous présentons quelques applications possibles par rapport à l'esthétique entre la hauteur du fût et la grandeur des têtes. Tous ces groupes peuvent s'adapter aux fûts de \varnothing 70 mm. Les modèles sont interchangeables, pour simplifier nous avons présenté le modèle 90 mais la même application peut se faire avec les modèles 91/92/93/94/95. Diffuseurs en polycarbonate transparent et opal sont disponibles. Accessoires IP44 et sources lumineuses page 106.

Hemos sugerido algunas aplicaciones posibles basándonos en la relación estética entre la altura del báculo y el tamaño del grupo óptico. Todos los grupos pueden ser adaptados a báculos que tengan una junta de \varnothing 70 mm. Los modelos son intercambiables. Para una mejor comprensión de las composiciones, hemos realizado un ejemplo con el modelo 90. Es posible tener los mismos grupos ópticos con los modelos 91/92/93/94/95. Disponibles difusores en polycarbonato transparente y opal. Accesorios IP44 y fuentes luminosas página 106.

